



Metal Detection for the Milling Industry



Why customers need Metal Detection

- To get the metal out
- Tramp metal damages processing equipment
- Product recalls are expensive
- Brand protection
- FDA, HACCP, and SQF all require it



Different Metal Types

- 1. Ferrous metals** have a very high permeability and are also good electric conductors. They are the best detectable metals.
- 2. Non-ferrous metals** have a very low permeability but are very good electric conductors. They are less detectable than ferrous metals, but better than stainless steel.
- 3. Stainless steel** has low permeability and is a not good conductor to electric current. Stainless steel is most difficult to detect with metal detectors. As there are different alloys of stainless steel, its characteristics depend on the alloy.



Basics of Metal Detection

- The sender coil produces an electro magnetic field with a frequency chosen for the application and product to be examined.
- The sender magnetic field induces a voltage in the two receiver coils. The 2 voltages are subtracted from each other, and the difference is amplified and filtered. Measured in millivolts.
- Each material which is magnetically or electrically conductive causes an asymmetry in the magnetic field of the receivers when it goes through the coils.
- Therefore, magnetic and conductive metals can be detected.

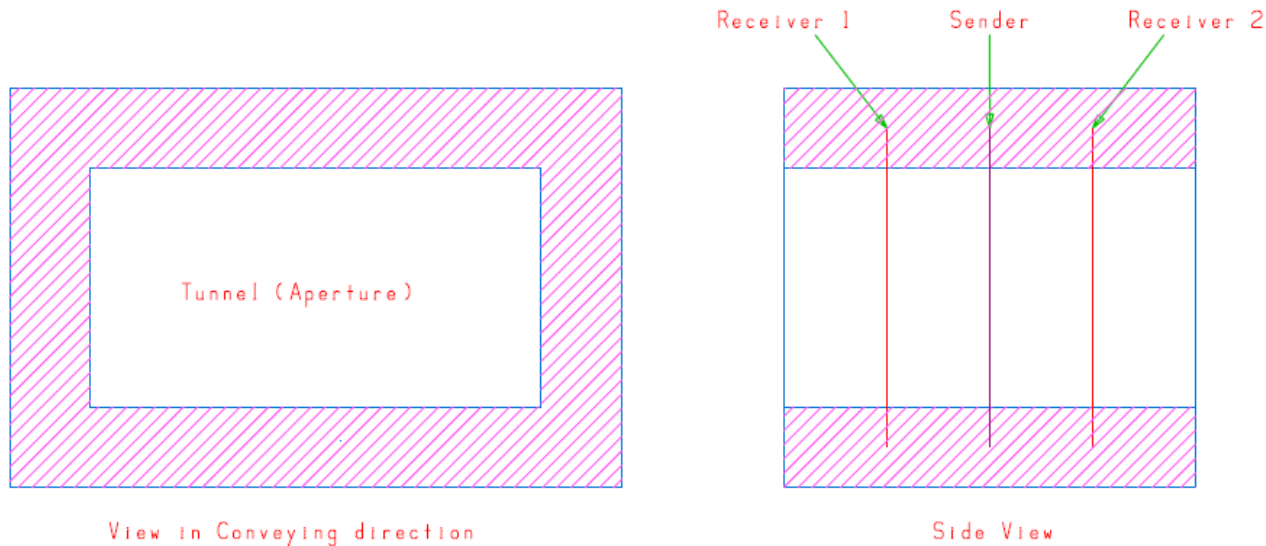

Basics of Metal Detection

- When a metal piece is put through the detection head, first the magnetic field of the receiver 1 is affected. The first half wave is produced.
- When it is on the location of the sender coil the influence on the magnetic field is equal for both receiver coils, so the resulting signal is zero.
- When the metal piece reaches the receiver 2 coil, the opposite half wave is produced.
- If the speed is constant a sine wave signal is the result.
- The peak voltages are exactly above the receiver coils.



Metal Simulation

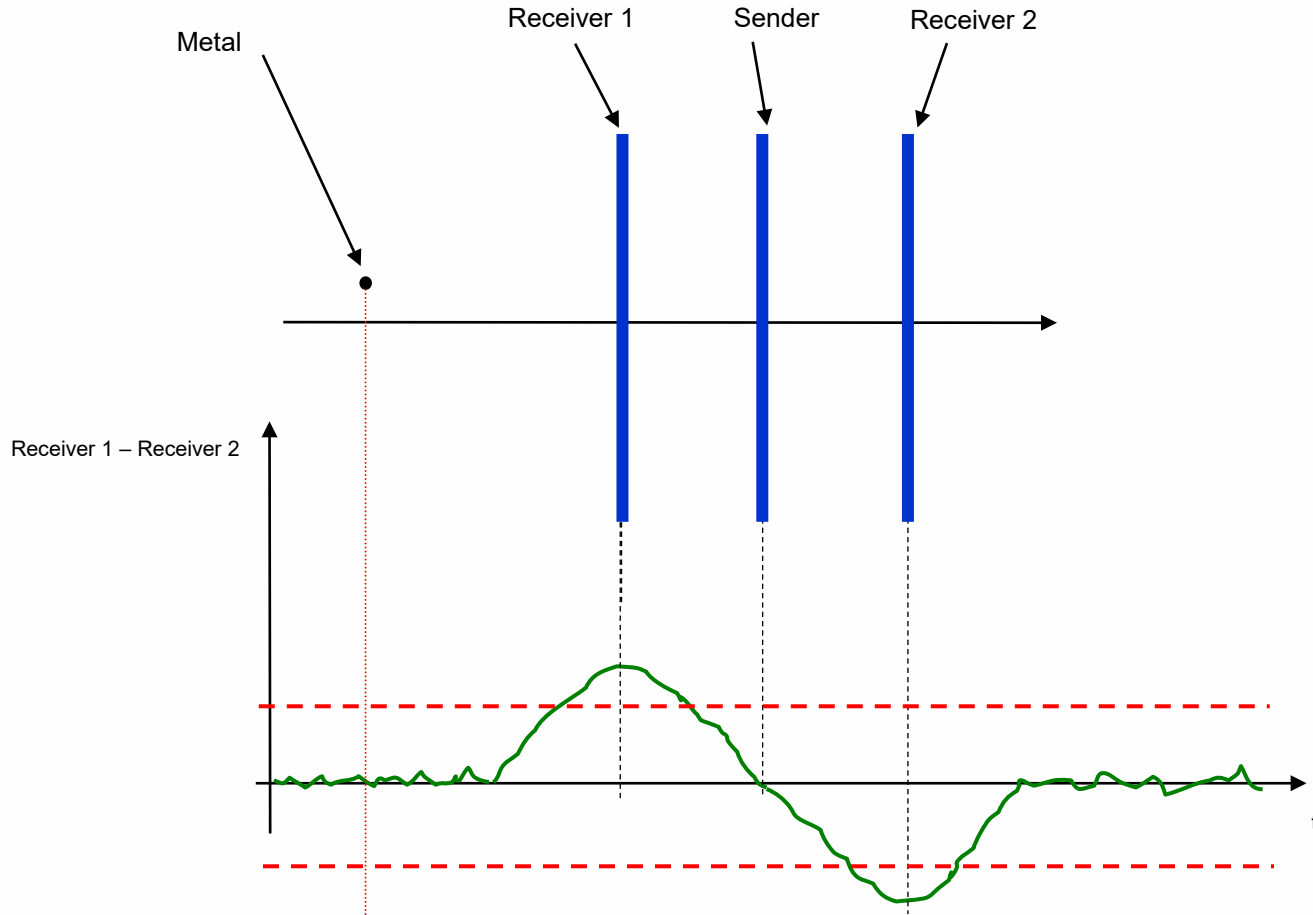

Basics of Metal Detection

To simplify it let's look at the 3 metal types. Fe, NFe, and SS.

- Fe – Highly reactive (magnetic) which equates to amplitude, 80°-100°
- NFe – Both reactive and resistive which equates to midpoint, 40°-70° / 110°-140°
- SS – Resistive which equates to phase, 0°-40° / 140° -180°

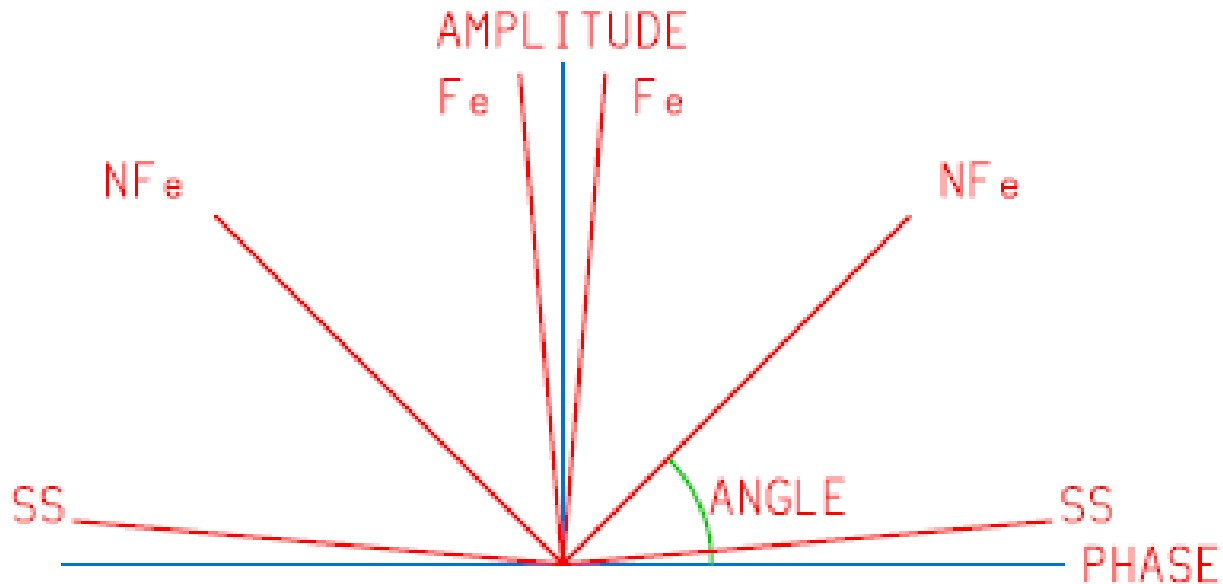

Requirements for Metal Detectors



- All events must be automatically recorded for traceability
- Password protected logins for security to be able to make any changes
- Tested regularly with certified test standards and recorded
- Calibrated at least annually by trained personnel

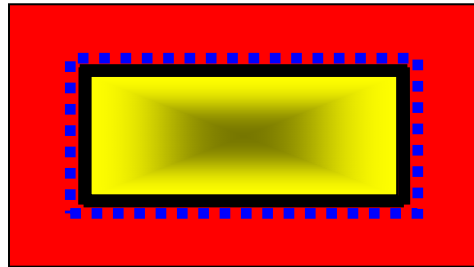

Sensitivity of Metal Detectors

Sensitivity is always stated and based on the dead center of the coil aperture



-  Area of highest Sensitivity
-  Area of lowest Sensitivity

Factors that influence a coils sensitivity:

- Aperture size
- Vibration
- Product signature
- Design Constraints
- Other Environmental issues



Sensitivity of Metal Detectors

Aperture size

- As the aperture size increases it directly affects the sensitivity
- Typically determined by:
 - Product, package, or bag sizes
 - Flow rate and bulk density
 - Flowability
 - Feeding line size
- For example: a 2" diameter aperture may see .4mm Fe, where a 6" may see .8mm Fe



Sensitivity of Metal Detectors

Vibration

- Vibration will affect the stability of the detector
- It can be learned or filtered, but it will lessen the efficiency of the detector
- Seen the same as and will affect ability to see Fe metals
- It is best to isolate the detector using flexible line fittings where possible
- Detectors in gravity applications should always be frame mounted and not supported by or support the conveying line

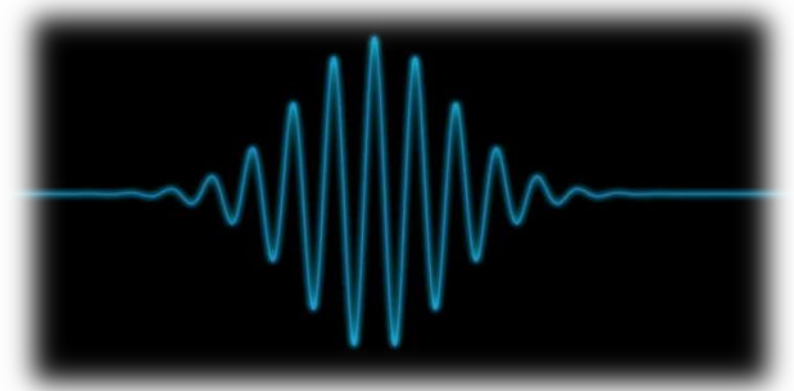

Sensitivity of Metal Detectors

Product signature

- Product learning will allow the detector to automatically tune out product effect
- Depending on the signature it will affect one metal type more than another
- Higher signature products may require a larger aperture to accommodate



Sensitivity of Metal Detectors

Design constraints:

- Following correct guidelines for installation
- Metal Free Zones (MFZ)
- Moving Metal Free Zones (MMFZ)
- Eddy Current loops
- Dedicated clean power supply

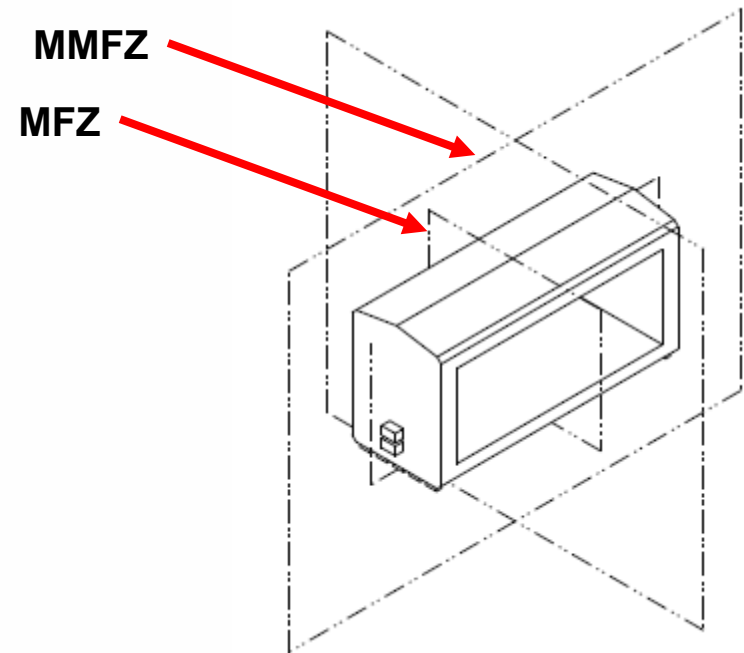

Sensitivity of Metal Detectors

Other Environmental issues

- High voltage power panels in the area of the coil
- High voltage power lines running next to or under the coil
- Never run a power cable or conduit in the Metal Free Zone
- Drive motors too close to the coil
- Infeed or discharge conveyors touching a metal detector conveyor
- Coiling excess power cables close to a coil
- Bolted frame construction (frames should always be welded construction)
- Electrostatic Discharges



Gravity Free Fall Metal Detector Application

- Typically sized by the line size in concert with the flow rate
- For incoming material, in process, and final product inspection
- Suitable for powders, granules, whole grains, etc...
- Multiple styles of reject devices depending on product characteristics
- Can be either with or without an automatic reject device
- Must always be in a complete free-fall condition



Gravity Free Fall Metal Detector

Gravity Free-Fall Metal detectors automatically detect and reject metal contaminants from free-flowing bulk materials.

- Clean product passes freely through the reject assembly.
- A contaminant in the product stream alters the high frequency field generated by the metal separator.
- The electronics evaluate this signal and generate an impulse for the solenoid valve and the double actuating air cylinder of the reject assembly.
- The contaminant is instantly diverted from the good product stream assuring minimal good product loss.
- The reject time is adjustable, in the case of several metal particles being present, the reject time will be extended accordingly to assure a metal free product.
- The reject gate returns automatically to its normal position after a successful metal rejection event.

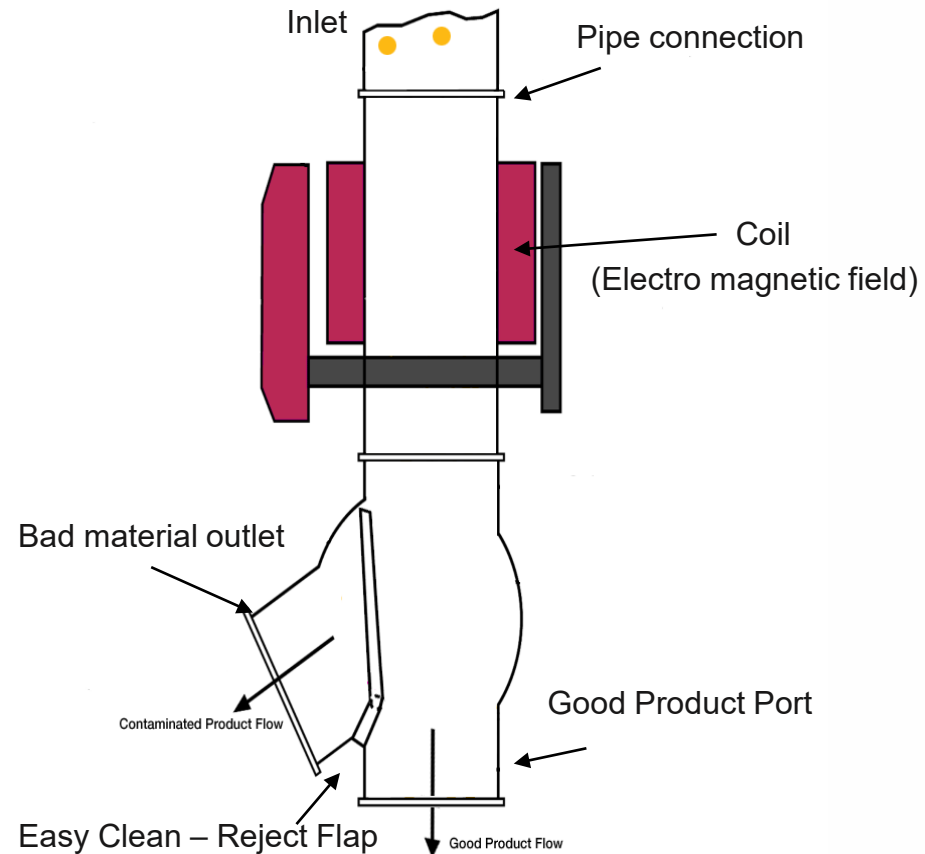

Pneumatic Conveying Metal Detector Application

- Protection for transfer lines
- Dilute phase Pressure or Vacuum lines
- Inspect product coming in from trucks and rail cars
- Inspect product loadout for trucks and rail cars
- Used for both horizontal and vertical conveying lines
- Sized according to conveying line size
- Suitable for Powders, granules, etc...



Tunnel Style Metal Detector Application

- One-piece tunnel detector for conveyor lines
- Suitable for bulk products or packaged products
- Can be integrated into the line or stand alone with reject devices
- Common CCP inspection

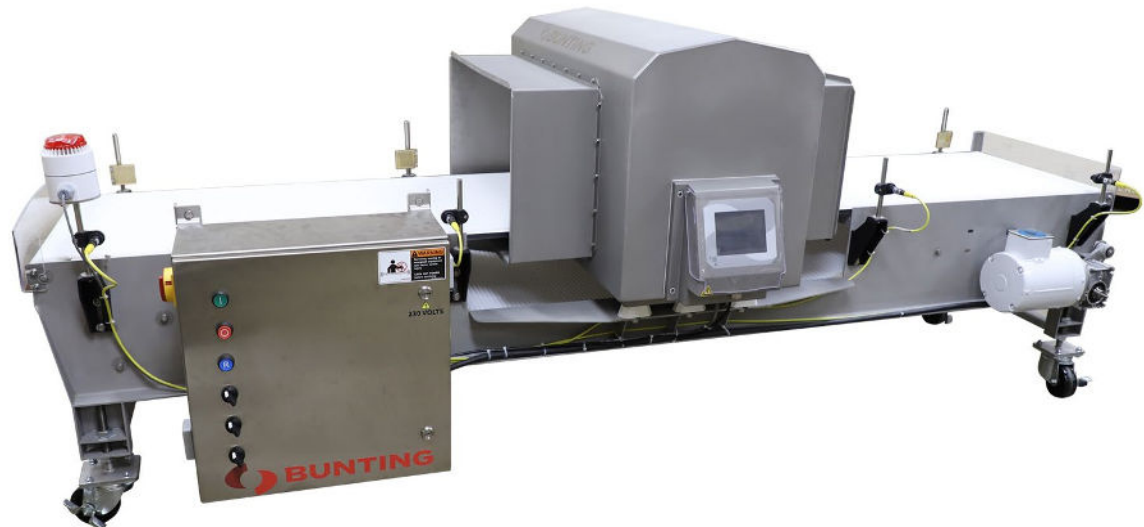

Proper Testing of a Metal Detector

- Certified Test pieces must always be used
- Always test all 3 metal types in order, Fe, NFe, and SS
- Recommend testing Stainless Steel using a 316L standard
- Multiple types and styles of test standards for each application type
- Frequency of testing is determined by the customer protocols
- Always test in a consistent manner in the center of the aperture

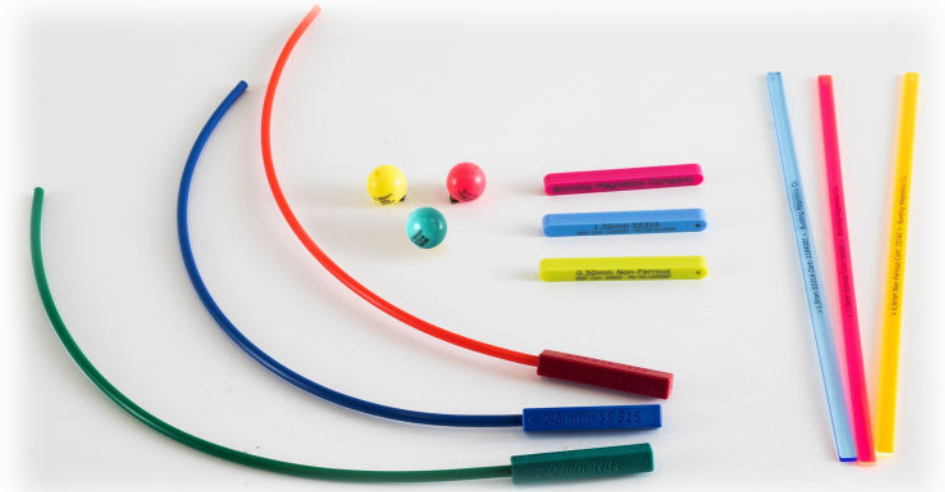

Contact Information

- Matt Wayne – Territory Manager – Southern CA, AZ, Southern NV
 - mwayne@buntingmagnetics.com or 714-580-8102
- Wendy Doll – Territory Manager – Northern CA, Northern NV, UT, WY, WA, ID, OR, AK, MT
 - wdoll@buntingmagnetics.com or 385-272-9477

