



International Association of Operative Millers 2013

Ho Chi Minh City, Vietnam 8-10 October 2013

R.Bontemps

F13/3890

Agricultural products: packaging



Sewing technique: plain sewn top

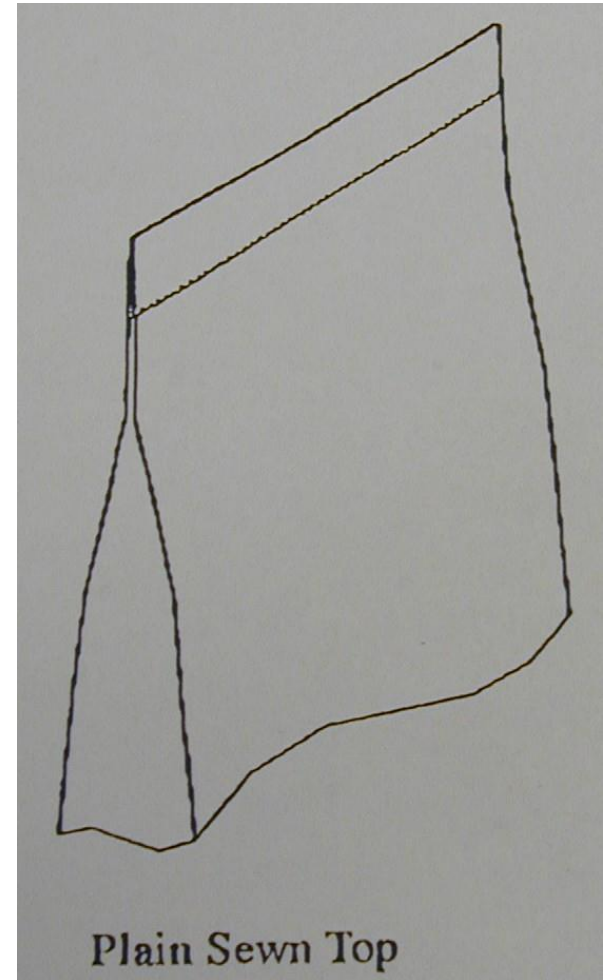
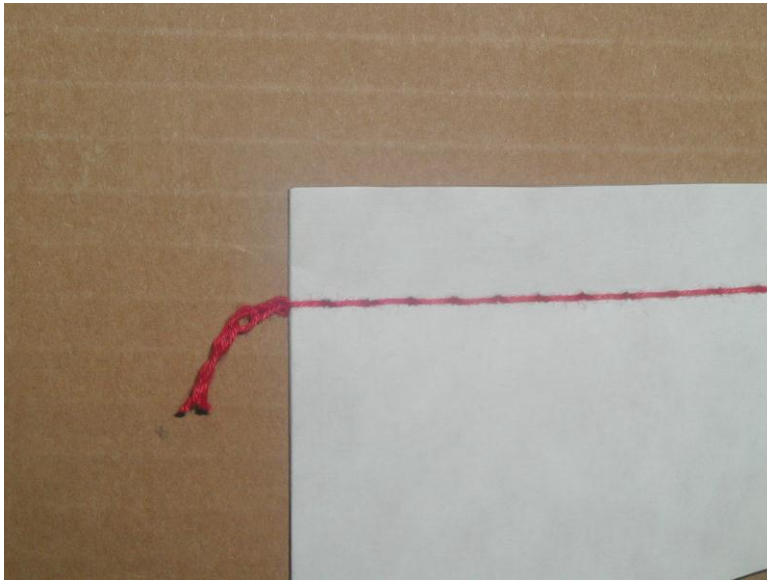

Sewing - manual operation: PORTABLE SEWING MACHINE



Sewing technique: fold over sewn top

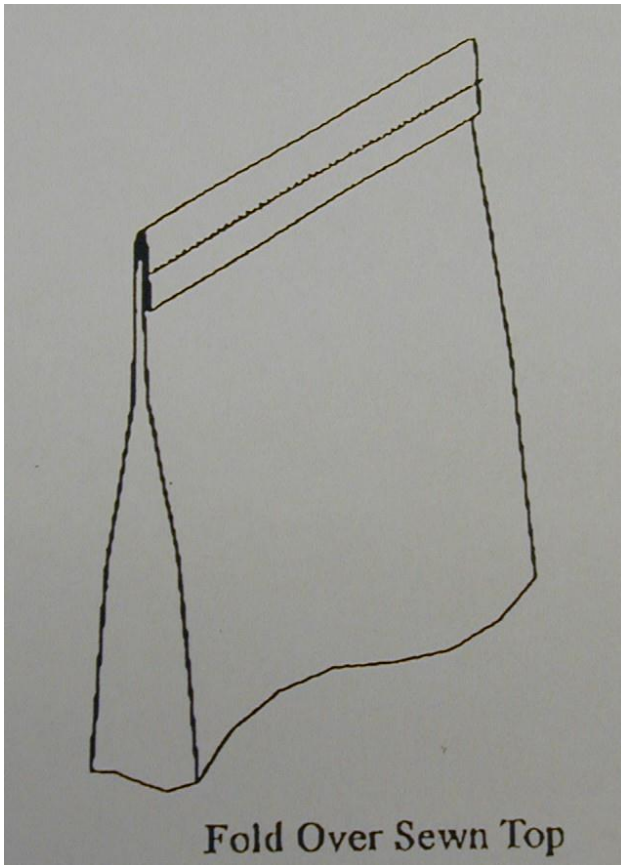

Sewing Technique :

Sewing with crepe paper

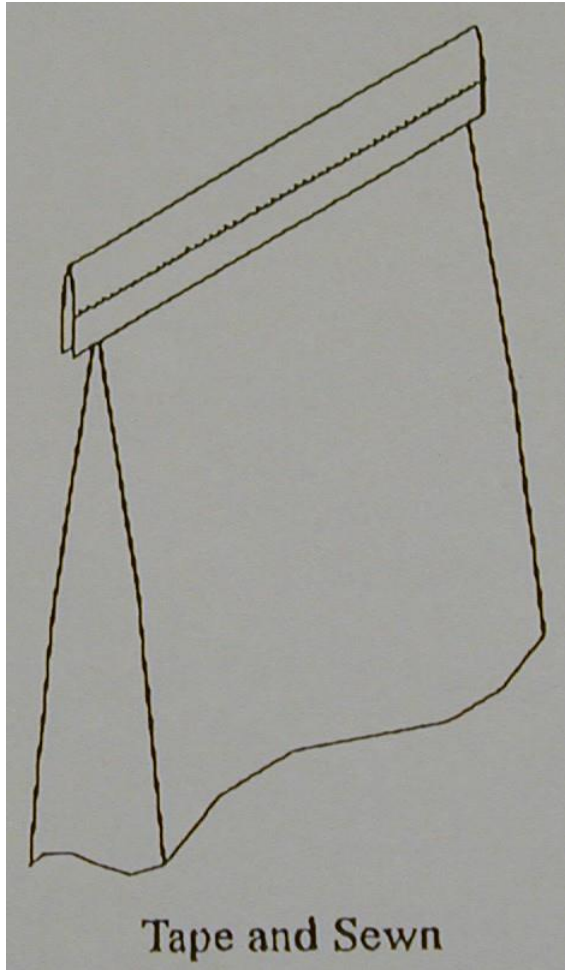

Sewing technique: easy open tape

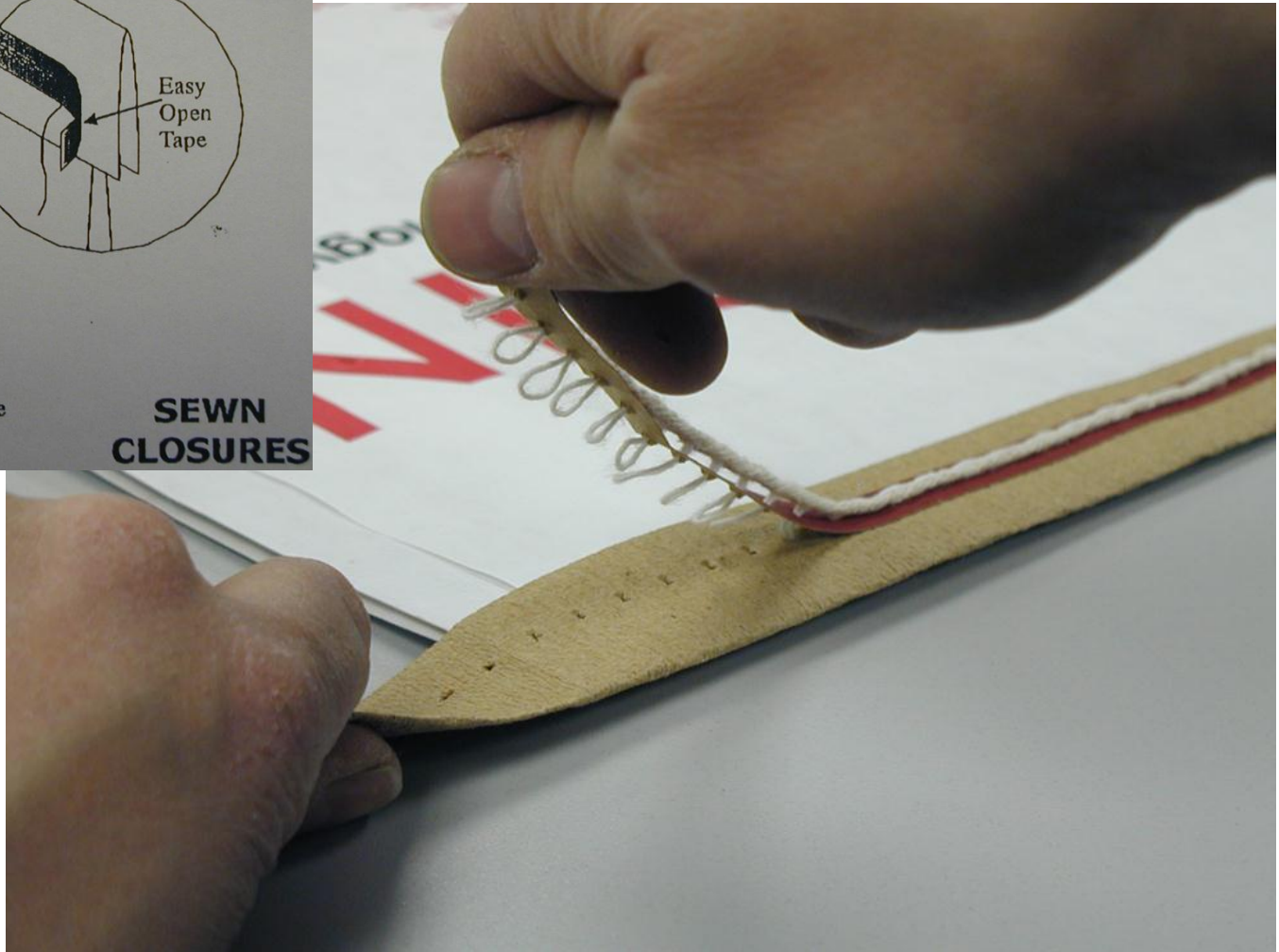
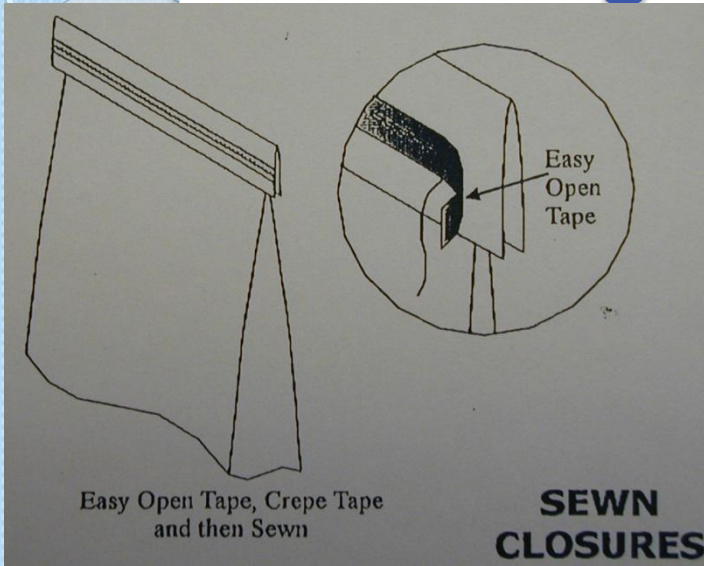

Sewing technique: tape over sew: new!



tape over sew : **New!** TOS 3000-SW



Sewing technique: twin closure - New!



Twin needle Sewing Head: **New!**

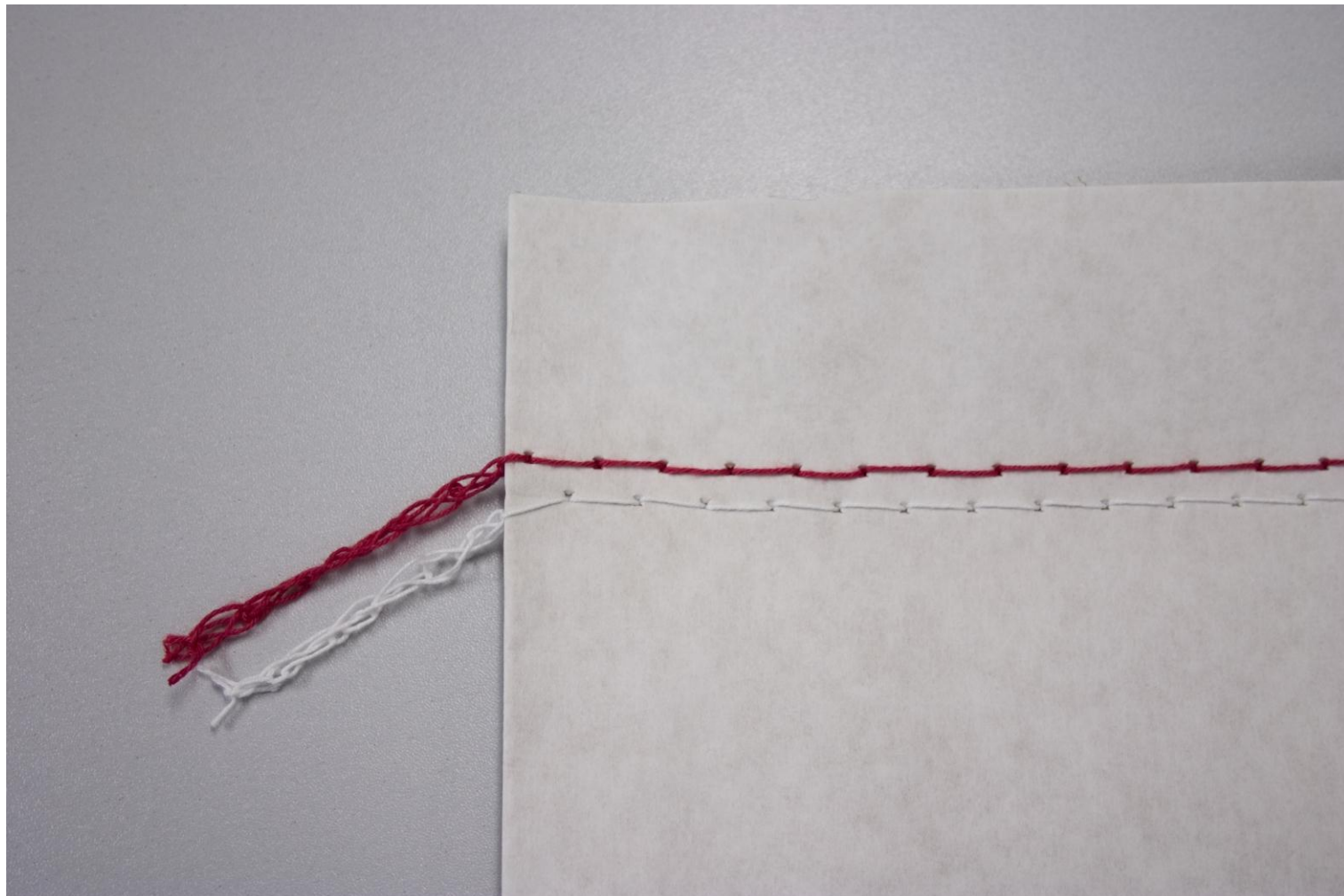

Key element for sewing: the Sewing Head!

KEY CHARACTERISTICS:

- Completely sealed in oil
- Variable speed, adjustable by pulley
- Variable stitch length
- Easy adjustments of thread tension
- A high performance rotary knife

Sewing System with infeed: automatic operation

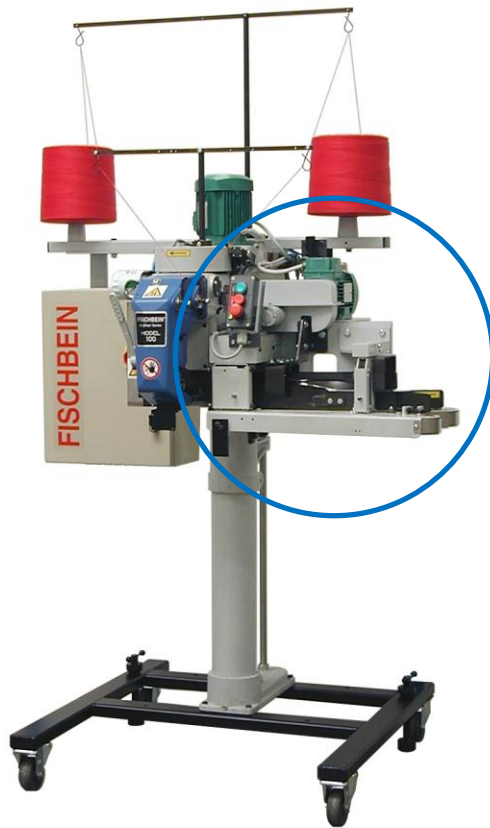

Fischbein infeeds

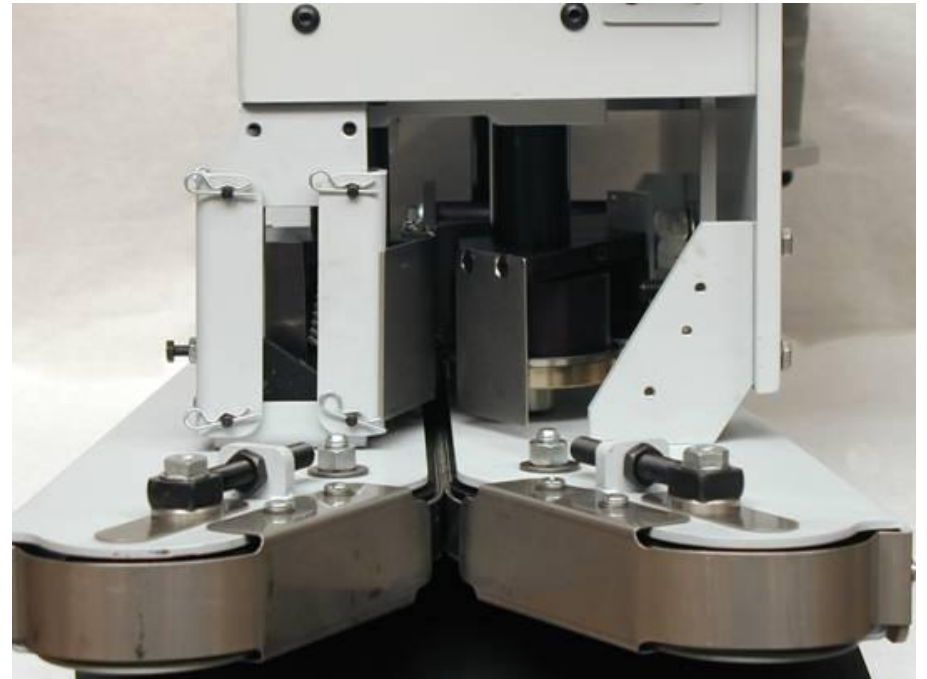
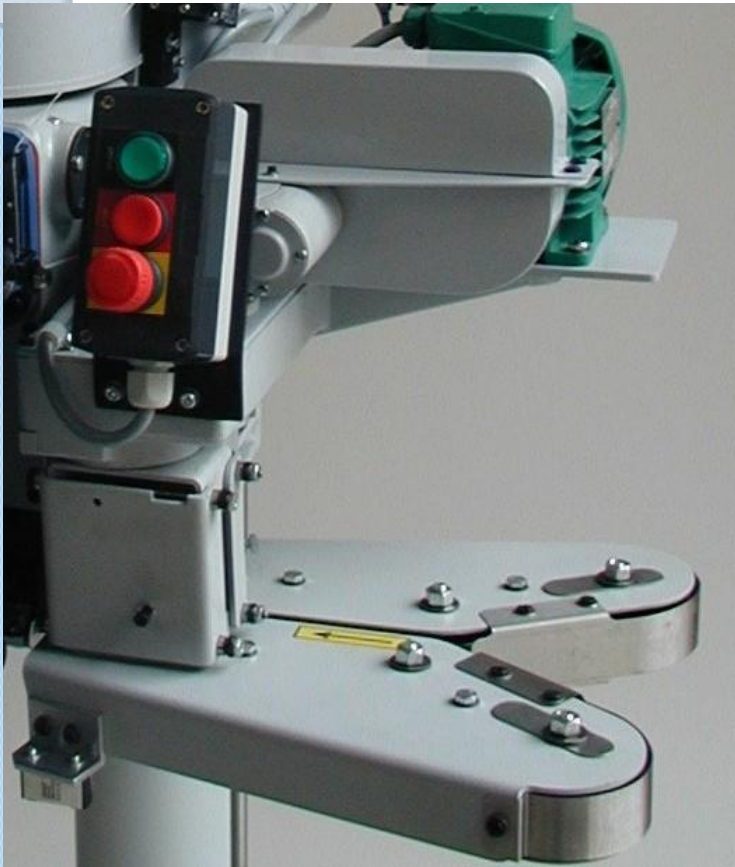

High speed sewing systems :New!



HIGH SPEED SEWING THANKS

TO:

- New in depth studies of mass movements
- Redesign of some parts
- New metallurgic composition
- Redesign of internal oil flow
- Special sophisticated surface treatments
- High performance rotary knife

Sealing technique



Sealing technique: convection

Hot Air sealers

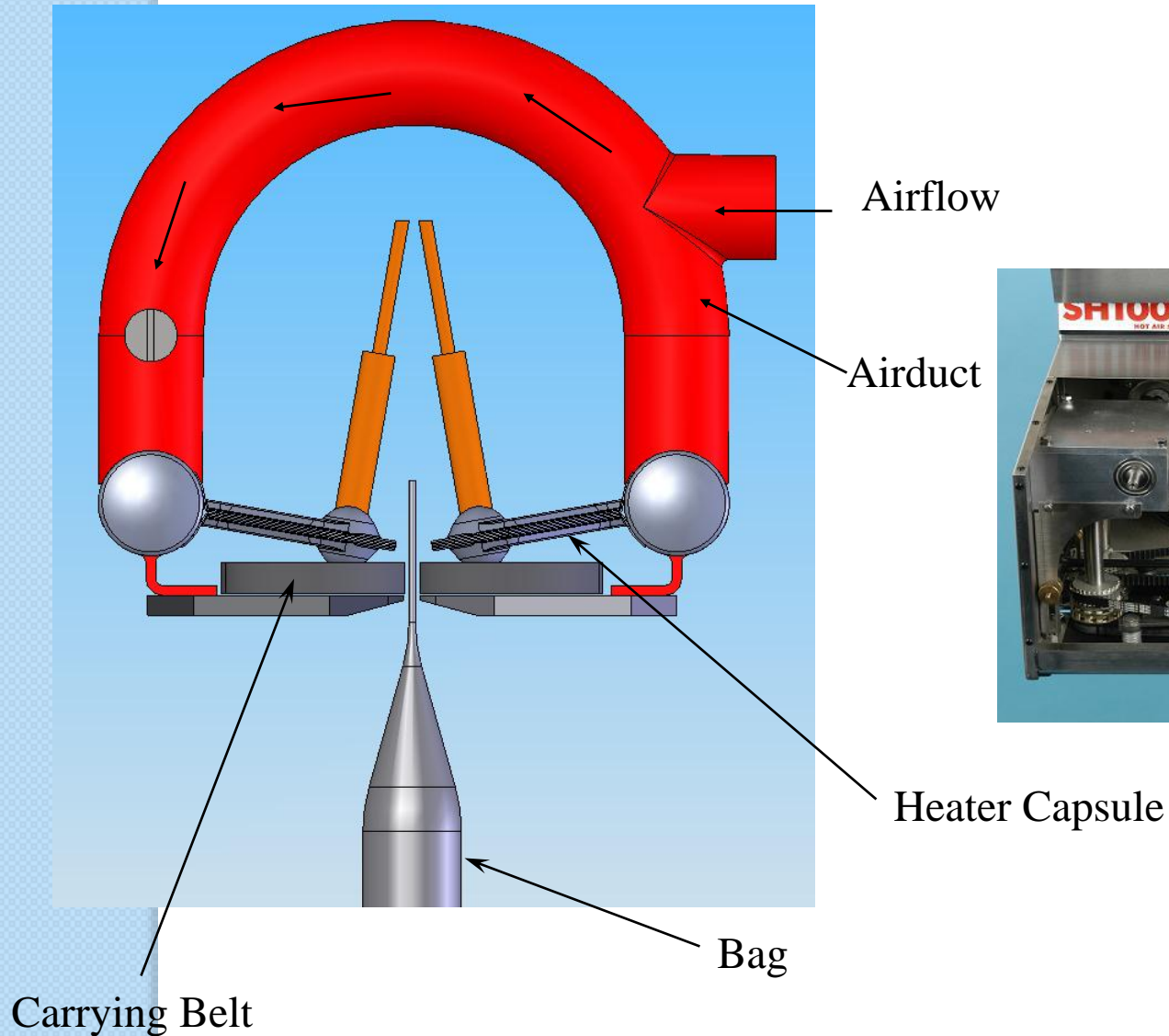

Sealing technique: conduction

Band sealers

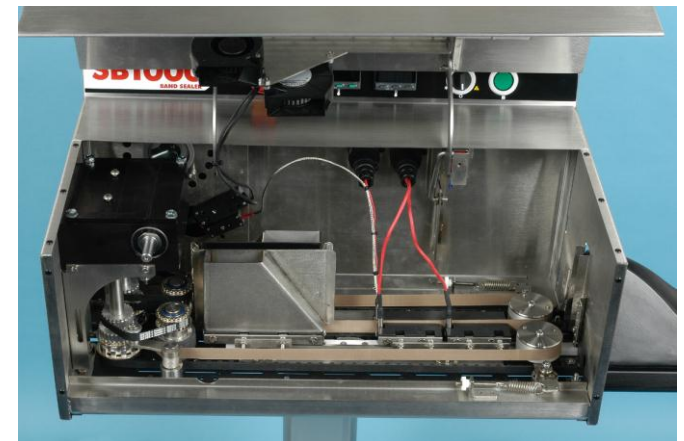
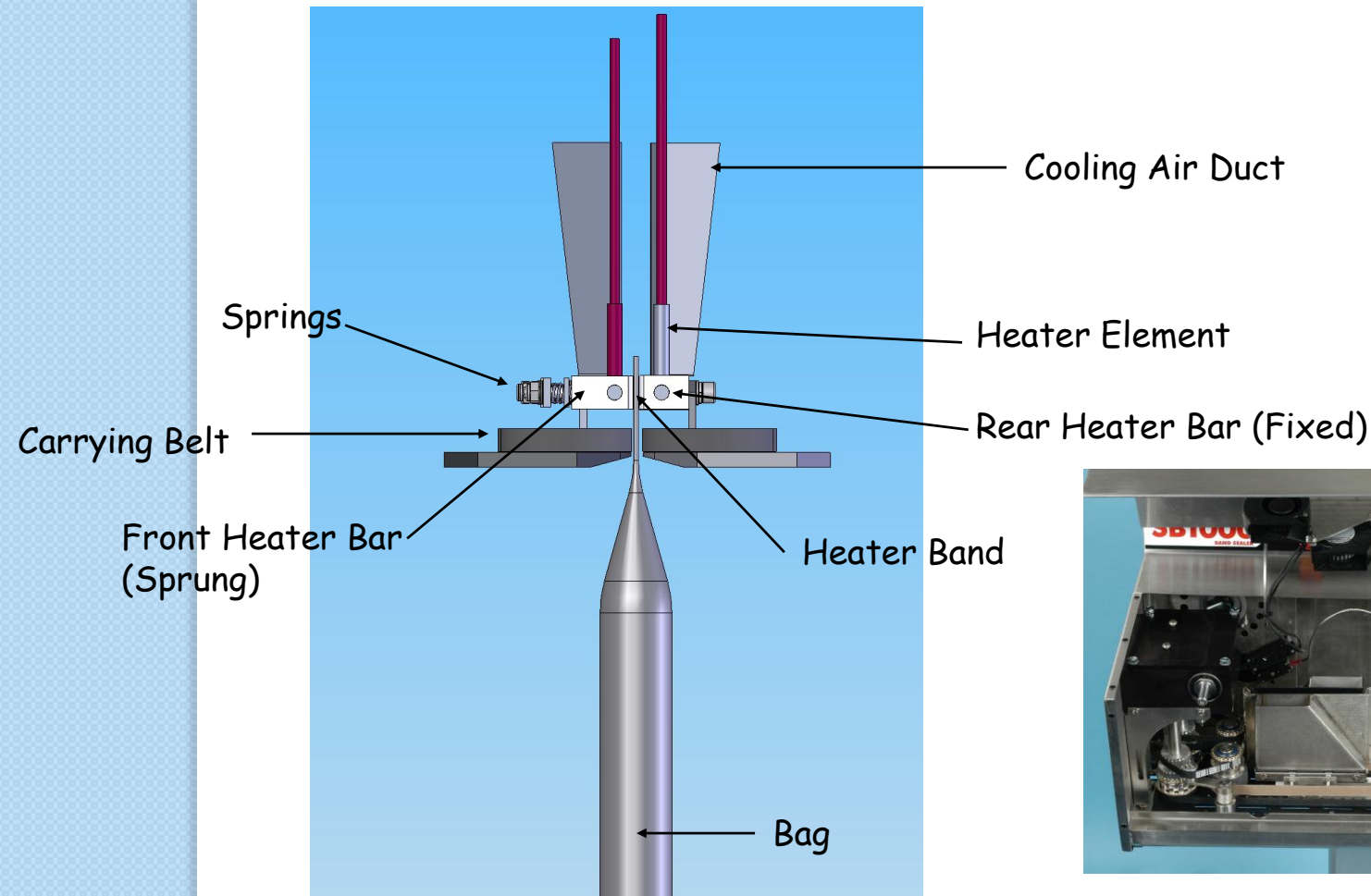

Sealing technique: radiation

Radiant sealers

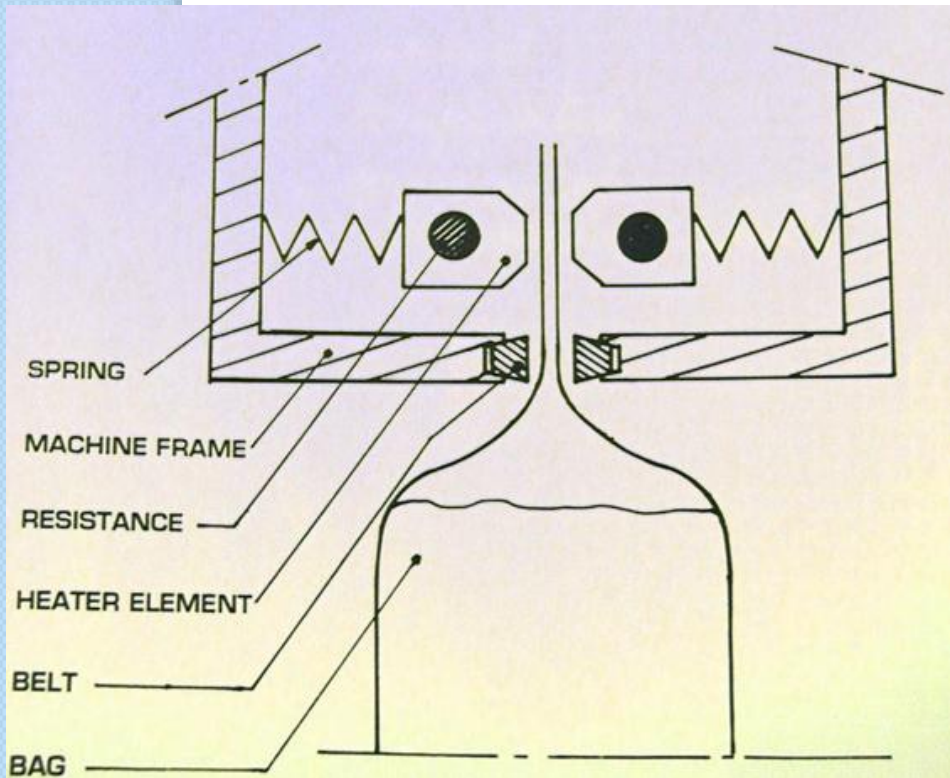

Crimp Wheels

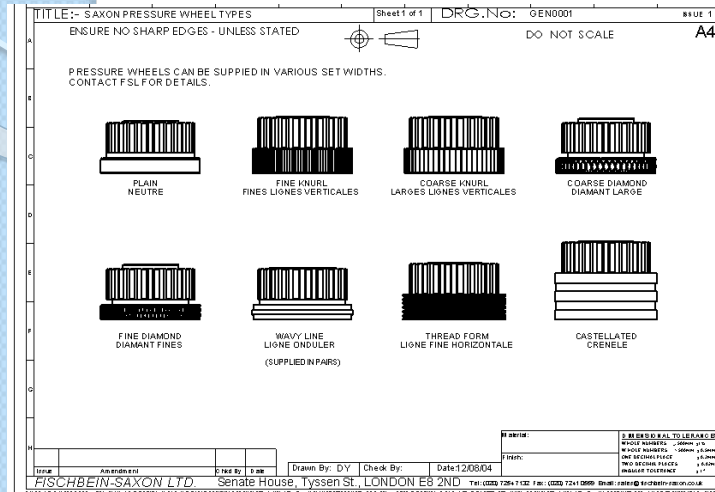

Airwash



Vortex bag cooler

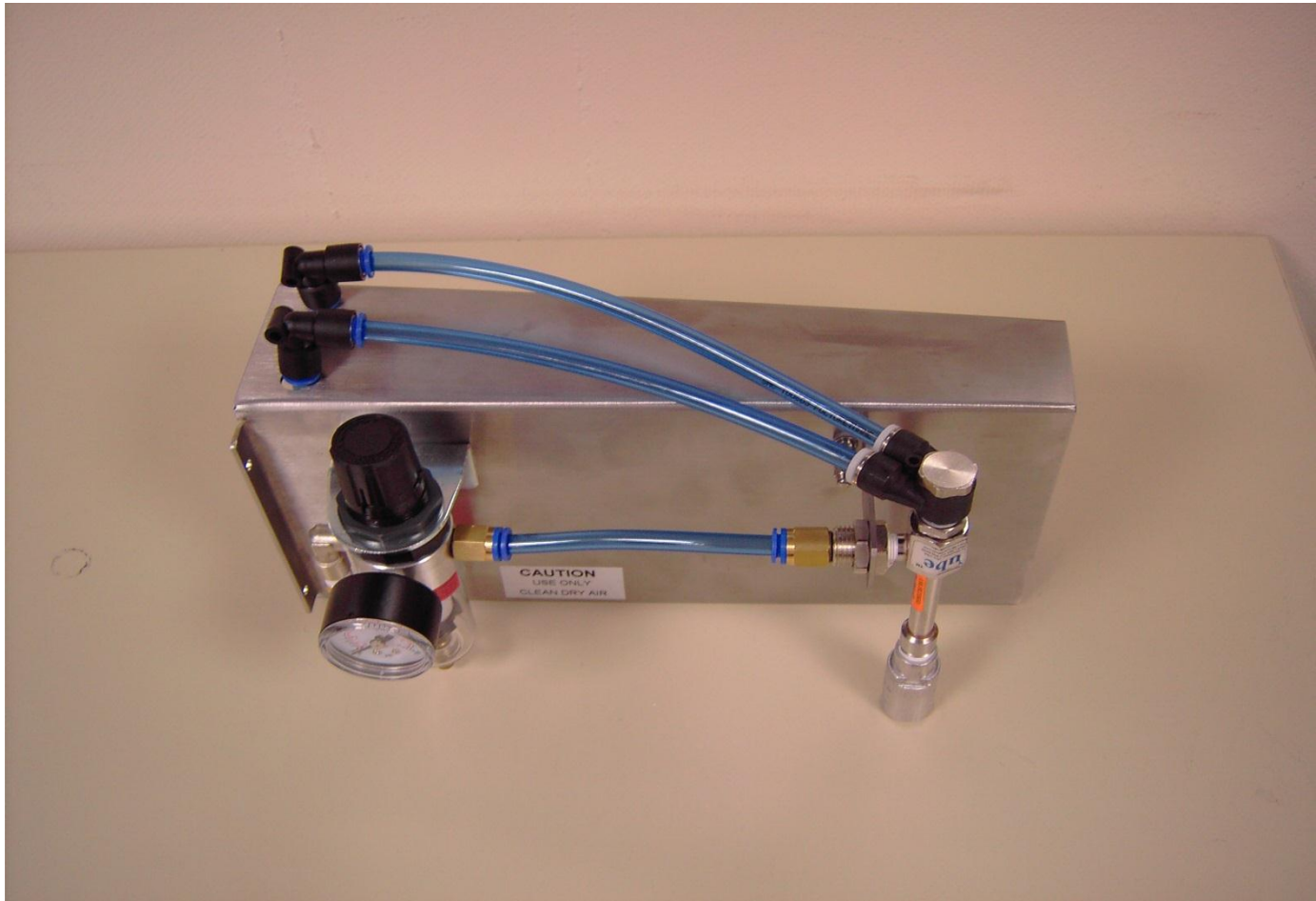

Bag Top Trimmer



Fischbein

- × SOLUTIONS

to your specific bag closing requirements from an extensive range of top quality equipment .

- × DEVELOPMENT

using the latest proven technology

- × WORLDWIDE SERVICE

through a large distributors network

- × « JUST IN TIME » DELIVERIES

of spare parts and new machines

- × QUALITY PRODUCTS