

# Economic Stabilization of Pallets for Safe Storage and Transport

**Grip Fix America Inc.**

[www.GripFix.com](http://www.GripFix.com)

80 Pine Street, 24th Floor

New York, NY 10005

Phone (832) 588 - 0467

[Clayton.Beaver@GripFix.com](mailto:Clayton.Beaver@GripFix.com)



# About Us

## Grip Fix America Inc.

[www.GripFix.com](http://www.GripFix.com)

- We are wholly owned subsidiary of H. Rand GmbH
- Founded in 1980 by Hemlut Rand, still run by the family
- Production in Neuhofen, Germany, 100 km south of Frankfurt

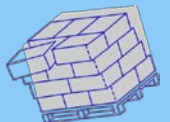

# About Us

## Grip Fix America Inc.

[www.GripFix.com](http://www.GripFix.com)

- We sell in 52 countries through exclusive partners
- North and South America, EU, Middle East, and Asia-Pacific
- 20% domestic (Germany) 80% global

## Our markets include:

- Milling and Foodstuffs (flour, baking mixtures, animal feed, ...)
- Biofuels/Wood Pellets
- Construction (mortar, cement, gypsum, talcum, ...)
- Chemical and petrochemical Industry (plastic granulate, salts, ...)
- Many others (lawn and garden products, seed, pigments, other industrial products)

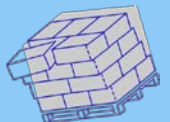

# Solving Problems in Distribution and Materials Handling

Safety of Pallet Loads



Cost of Rejections



Cost of Packaging Material

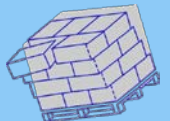

# Concept of Stabilizing Pallets

## 2 Part System

**GRIP FIX®** waterbased and solvent free Antislip Agents

**BAG FIX®** application systems for applying GRIP FIX

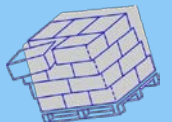

# GRIP FIX : The Heart of the System



- Waterbased & solvent-free
- More than 120 different GRIP FIX formulations
- Suitable for many substrates, including PE, paper, or cartons
- FDA compliant for food packaging
- 100% biodegradable
- Zero carbon footprint

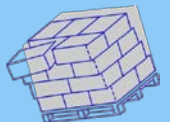

# How does GRIP FIX™ work?

## The Trick:

- High shear strength and low tensile strength
- The pallet loads do not slip but can be easily separated

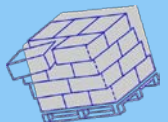
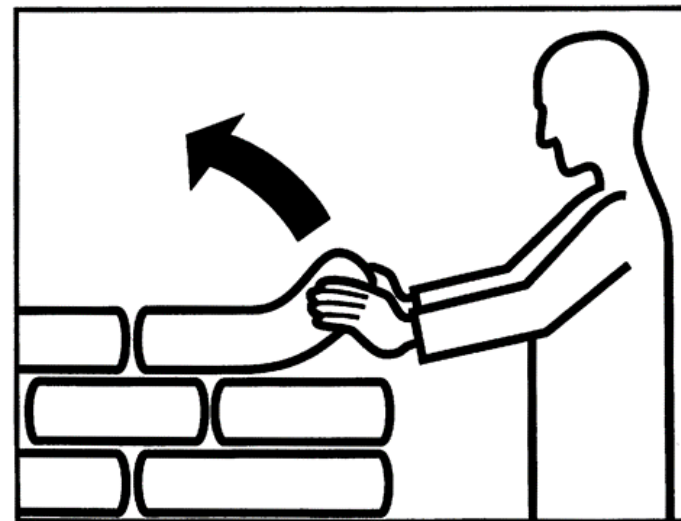
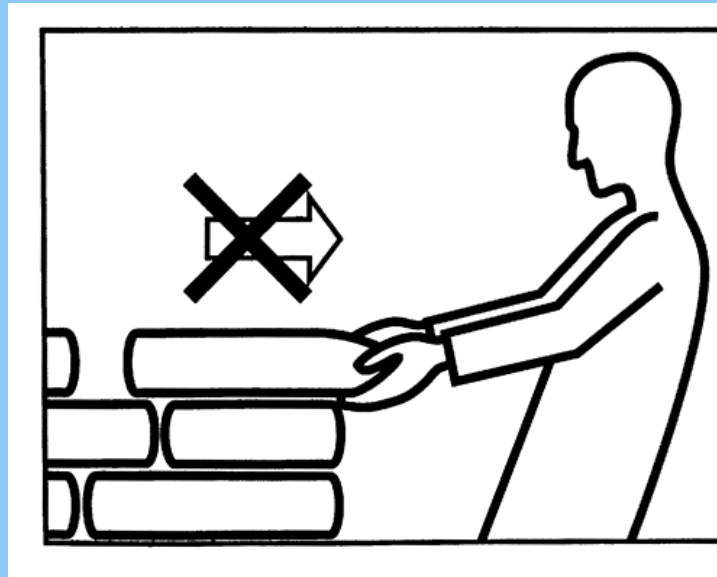
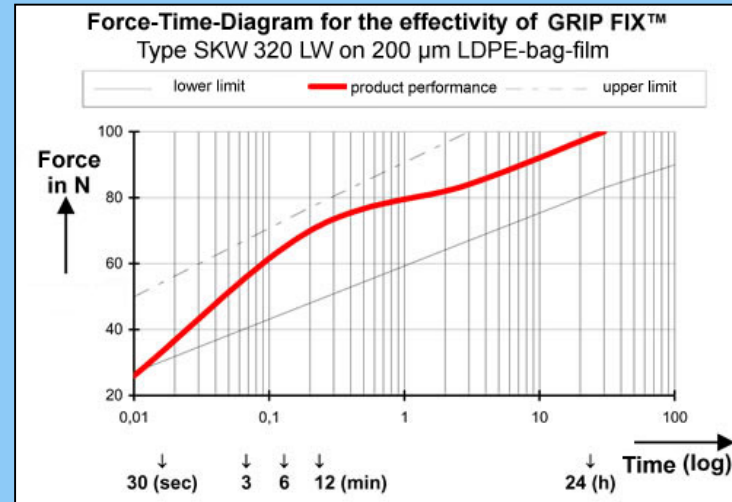

# How does GRIP FIX™ work?



- GRIP FIX™ is applied in small quantities to single packages before palletizing.
- After a short drying time, the pallet is stable and remains so until the pallet is unloaded.

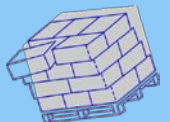



# Stabilizing Pallets

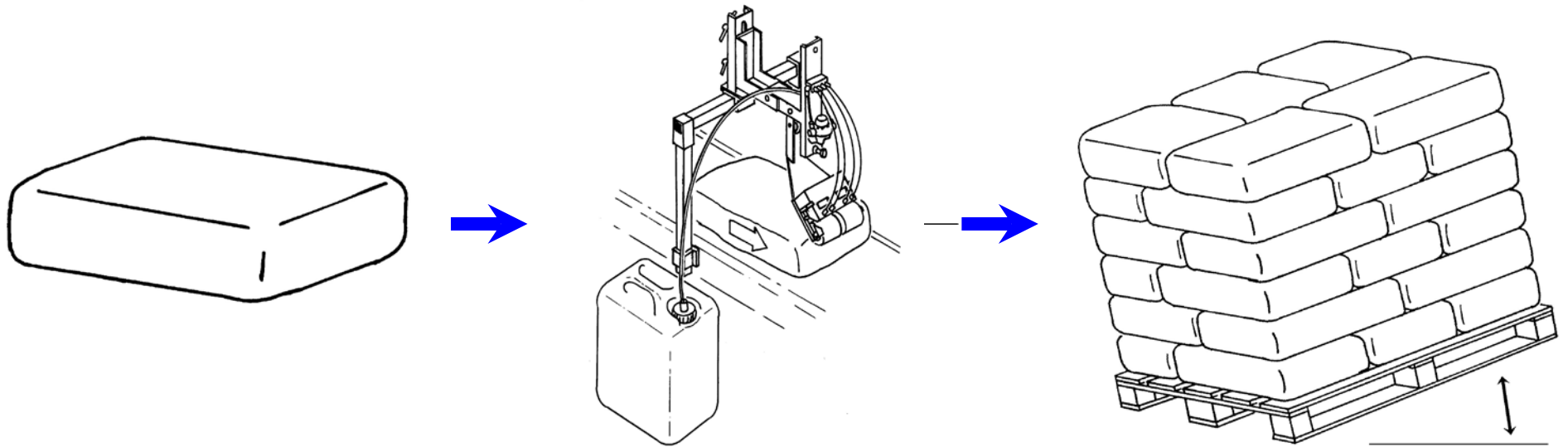

## Consumption per package:

PE-Bags	0.5 - 1.0 g
Paper-Bags	1.5 - 2.0 g
Cartons	1.5 - 4.0 g

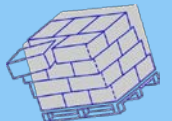

# BAG FIX Application Systems



**BAG FIX™ Application Heads**

**12 different BAG FIX application systems are available:**

- Manual
- Fully-Automatic
- Contacting or Contact-less Application
- Customized Systems

**So far 2500 Bag Fix Systems have been installed in 50 countries**

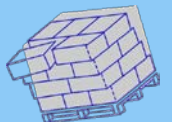

# BAG FIX Application Systems



- Small Footprint allows for easy installation
- Robust design
- Economical alternative to stretch hooders and shrink wrappers
- Quick-release closure produces a closed system
- Wide range of packaging, from 1 kg up to 1000 kg

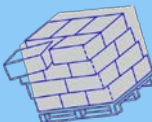

# Advantages for the Milling Industry

- **Increased Safety of the Distribution System**
- **Reduce Packaging, Labour Costs, and Rejections**
- **Potential Increase in Shelf Life**
- **Contributes to a cleaner Environment**

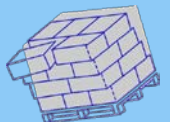

# Reference

## Industry of our Customer:

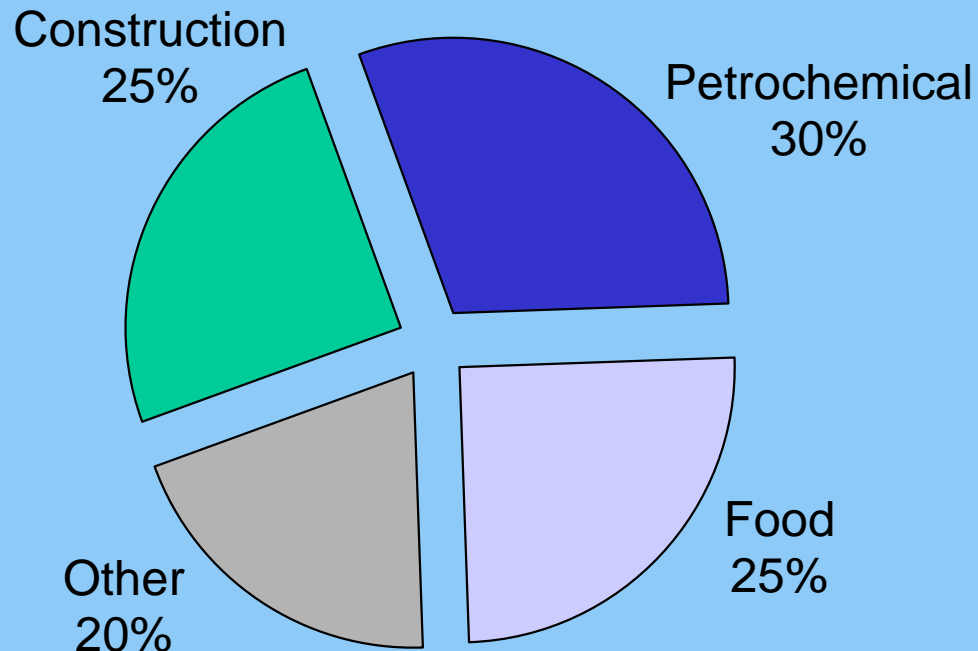

## Customers Include:

(alphabetical order)

BASF

Bayer

Borealis

DOW

Evonik

ExxonMobil

Knauf

Unilever

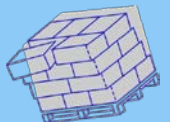

# Unilever: Handsoap



- Stabilizing with GRIP FIX and a string for the last layer
- Savings on cost and garbage of about 14 t stretchfilm / year

## Facts:

- 32,000 t of soap / year
- Export to 86 countries
- 117 cartons per pallet (660 kg)

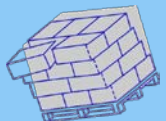

# Sano: Animal Feed



- Stabilizing with GRIP FIX
- Savings on cost and garbage of about 45 t stretchfilm / year

## Facts:

- 180,000 t of pet food / year
- Export to 12 countries
- 40 paper bags / pallet (1,000 kg)

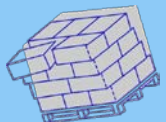

# Molino-di-Assisi



- One of nearly 200 BagFix units installed in milling in Italy
- Flour mill, part of the Grigi Agricultural group
- Stabilizing with Grip Fix
- Eliminating stretch film reduced condensation, resulting in 50% increase in shelf life

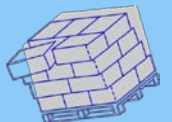



# P & H Milling



- First flour mill with a Bag Fix unit installed in North America(2019)
- Shipping full rail cars across Canada using only Grip Fix
- Eliminated stretch film on one product line. Still calculating savings

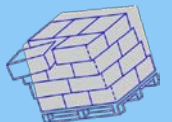

# Grain Craft

GRAIN  CRAFT



- 5 lb display ready pallets for retail, 15 layers high
- Without Grip Fix, 1 pallet in 10 able to ship
- With Grip Fix shipping 10 /10 pallets

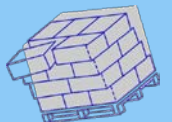

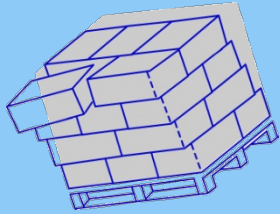

# Palletizing Safety Systems

**Grip Fix America Inc.**

[www.GripFix.com](http://www.GripFix.com)

80 Pine Street, 24th Floor

New York, NY 10005

Phone (832) 588 - 0467

[Clayton.Beaver@GripFix.com](mailto:Clayton.Beaver@GripFix.com)

# Questions?