

Creating Values for Millers in South East Asia

IAOM 2014



What is important for Us ?

■ → High yield

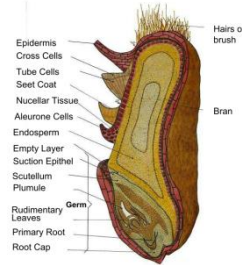

■ → Low Production cost



■ → High quality products



■ → Food Safety



.... Challenges for Operation Millers *

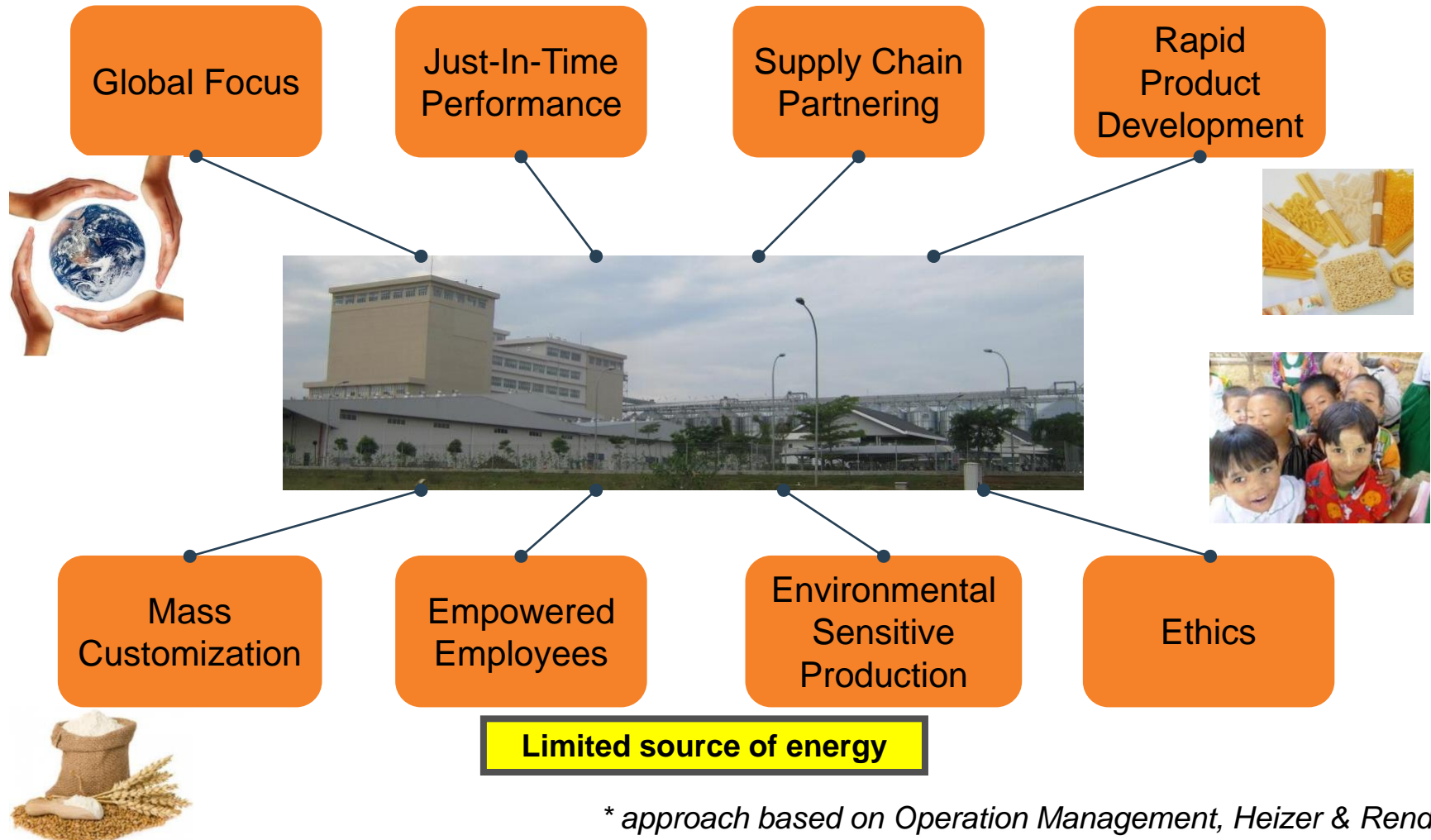

* approach based on Operation Management, Heizer & Render

Energy Consumption Analysis

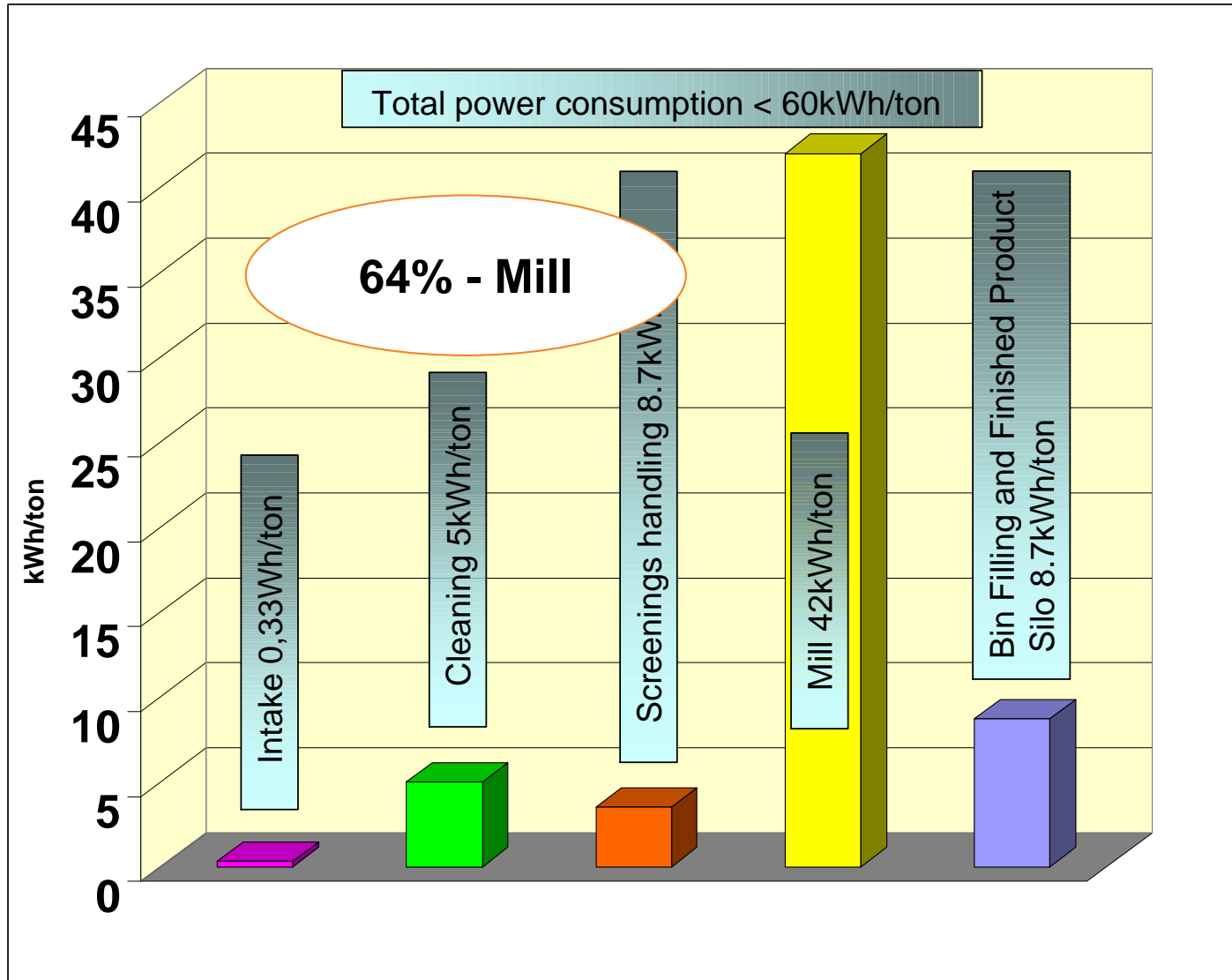

Energy Consumption Analysis

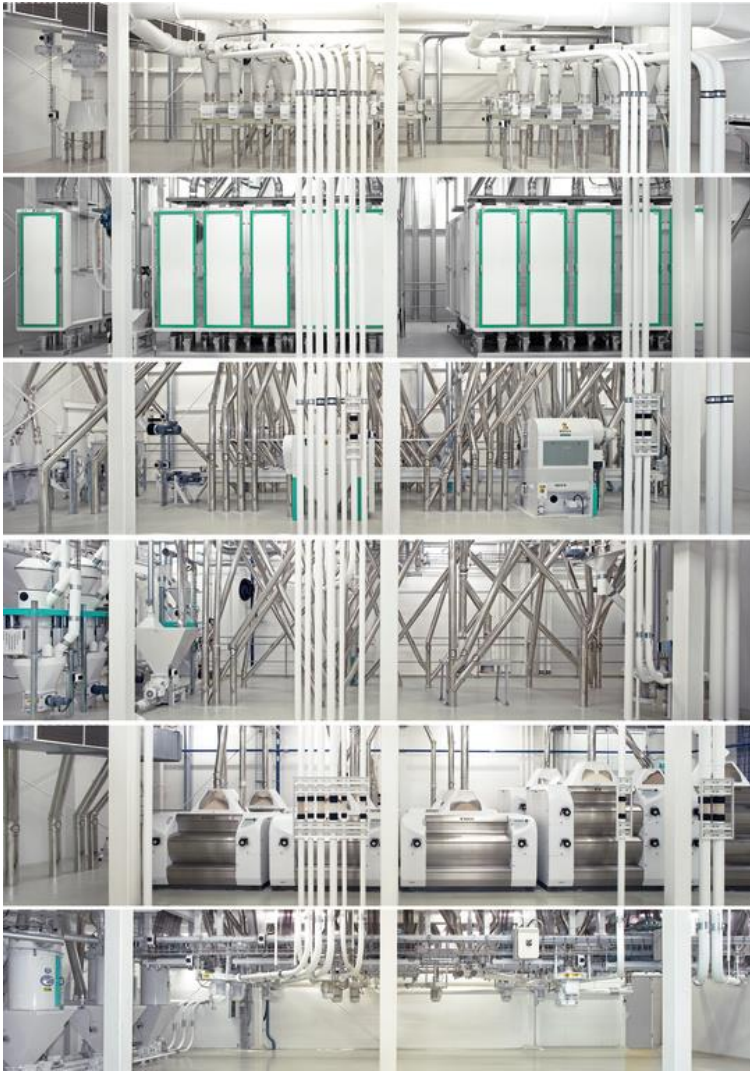

**50 - 65%
Roller Mill**

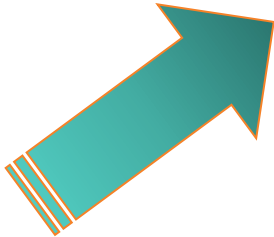

After cleaning

Overview of a flour production plant

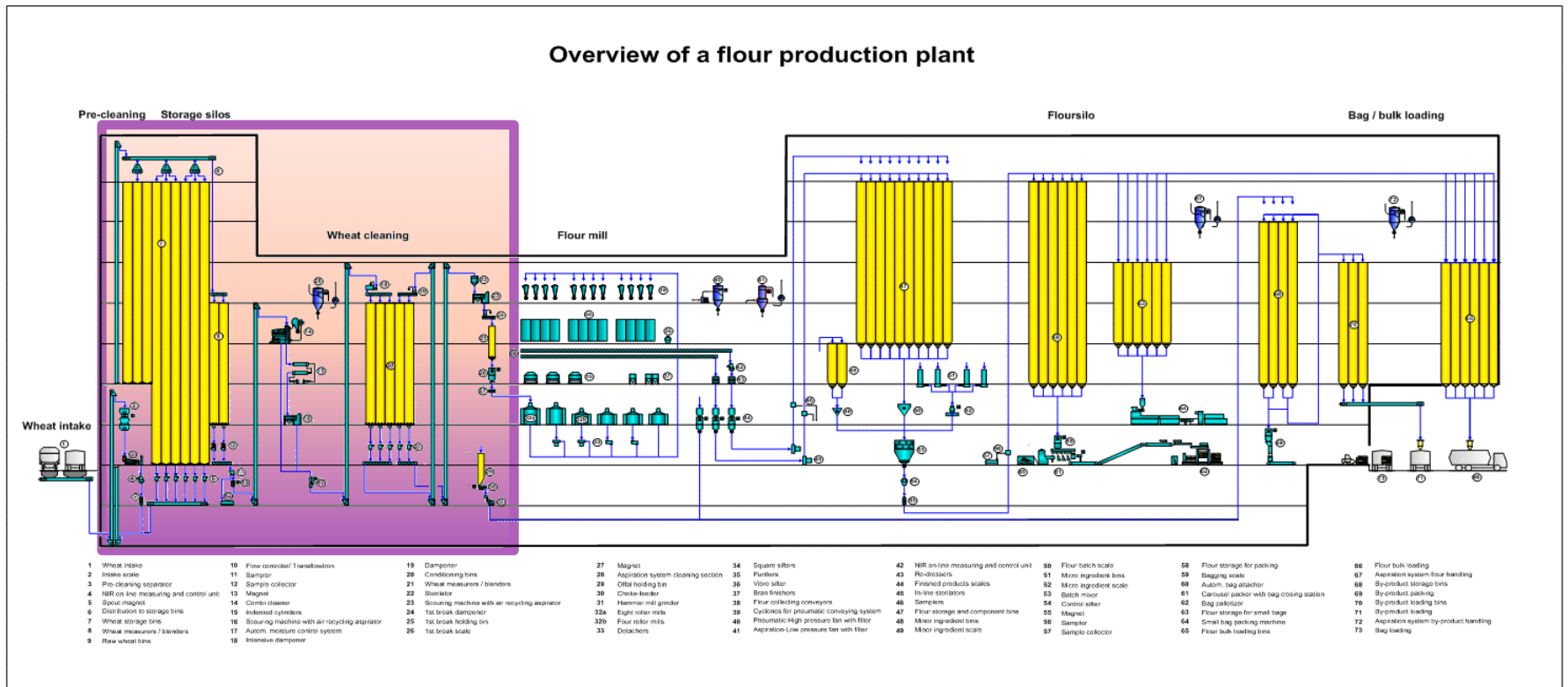

Breaking, Cutting, Opening



Master Miller



Overview of a flour production plant

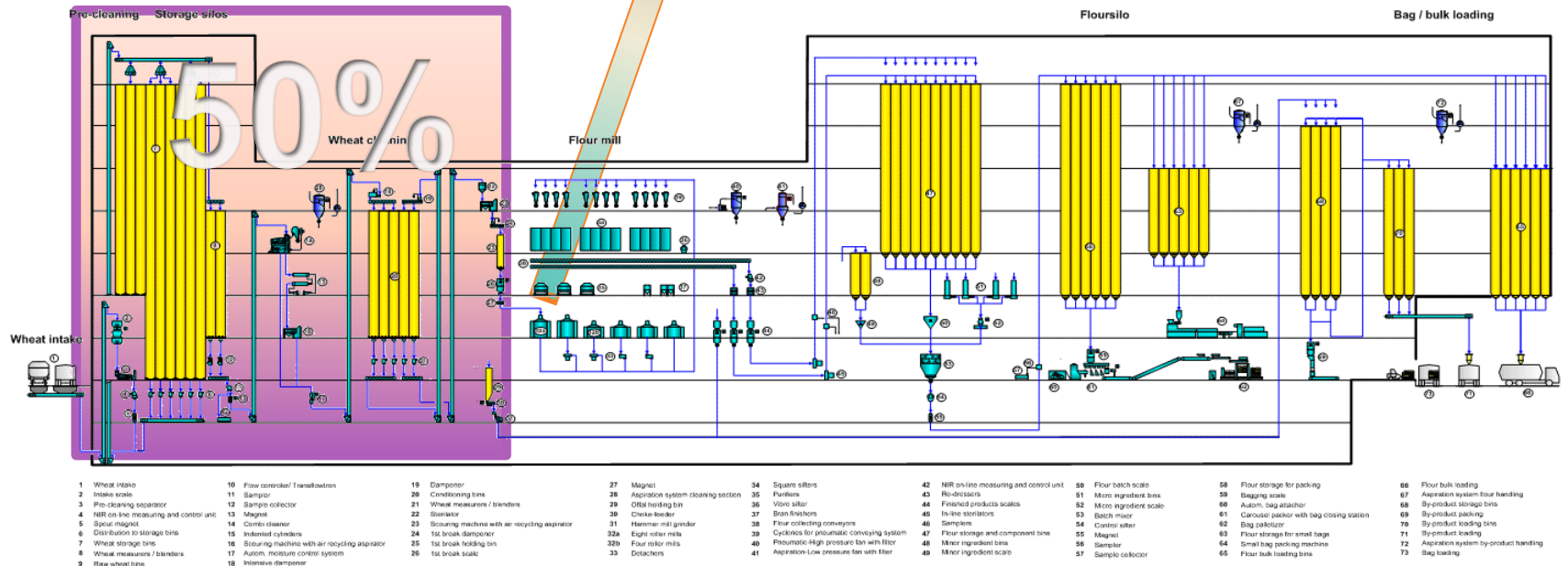

Opening of the kernel

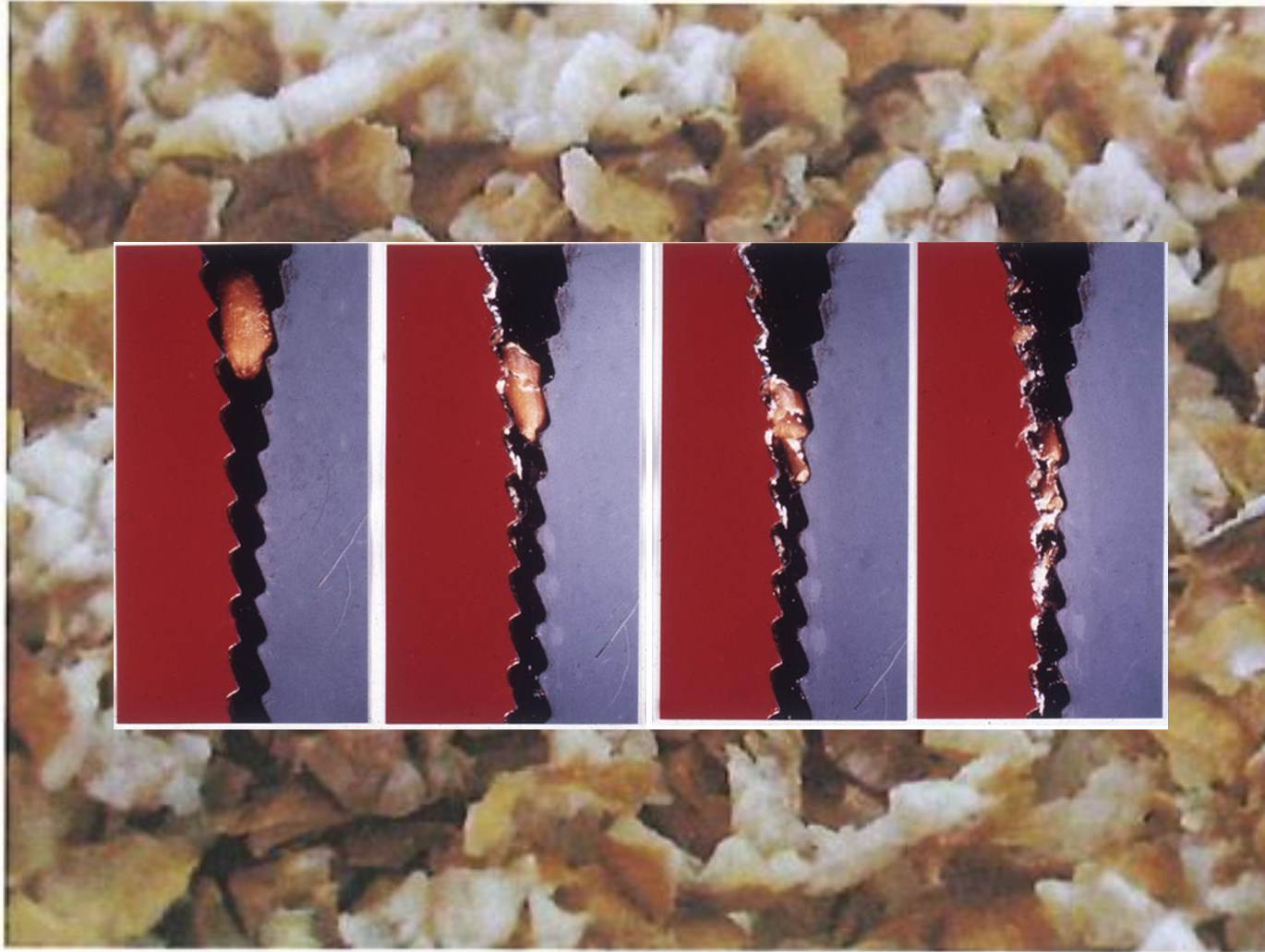

Rolls ... knowing deeper ...

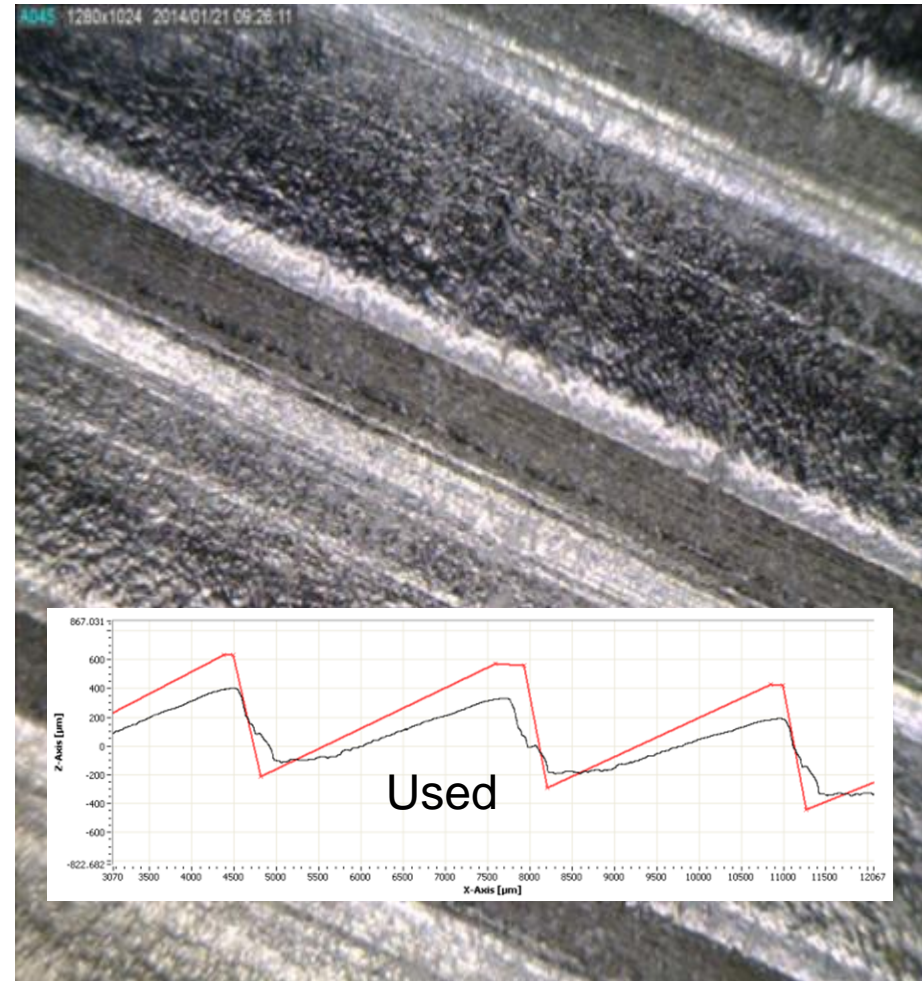
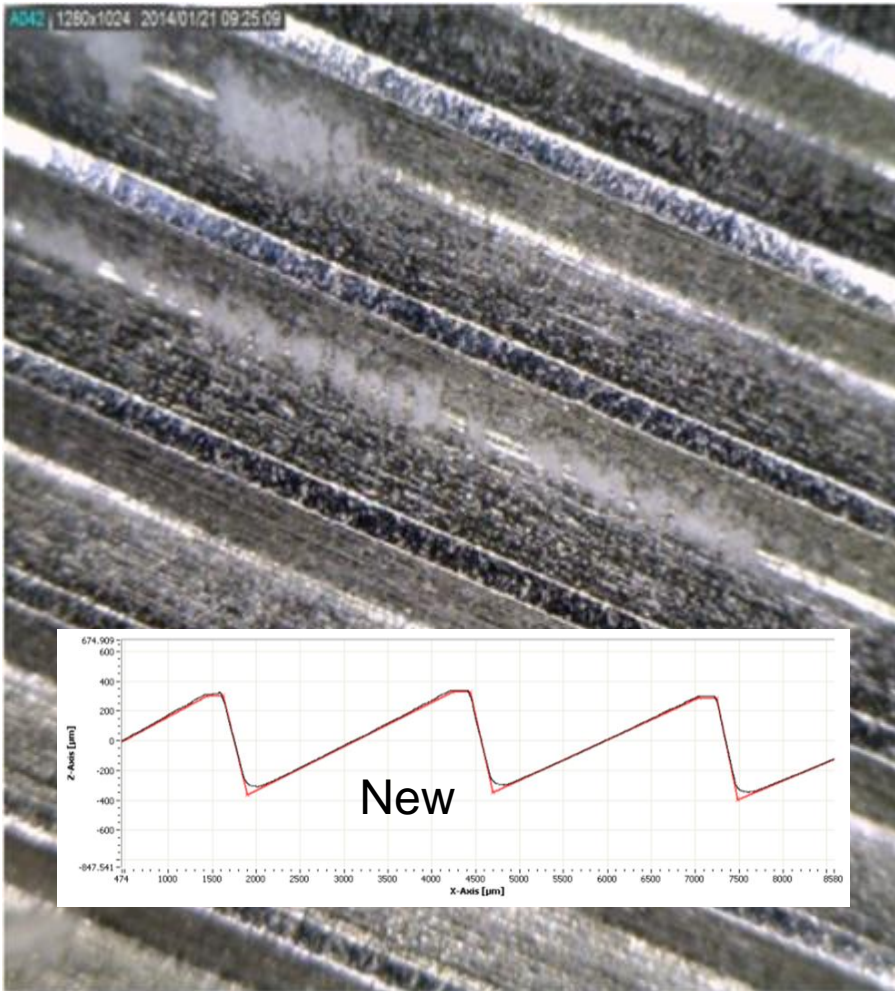

Rolls that have touched and have altered the land.

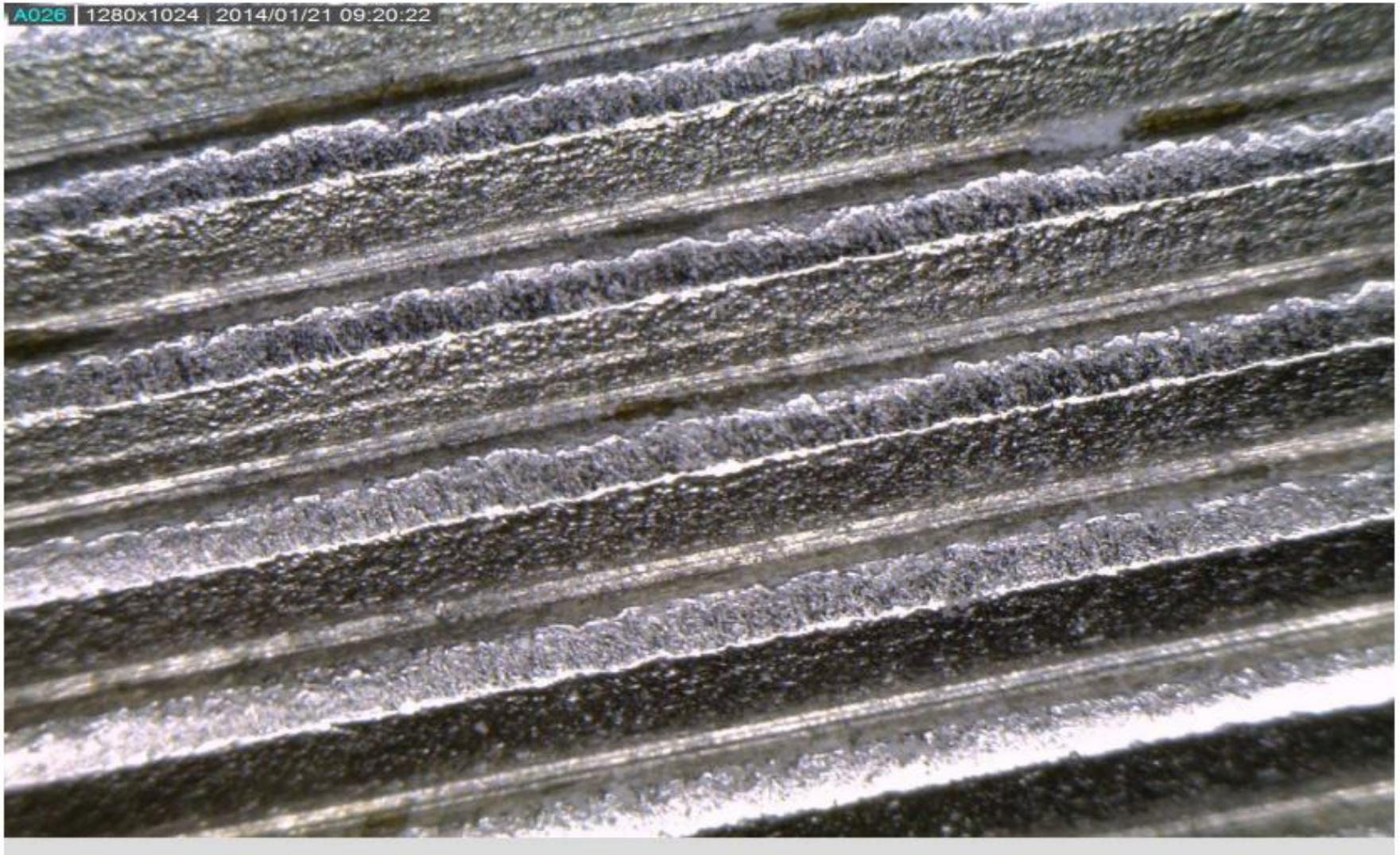

Rolls Performance

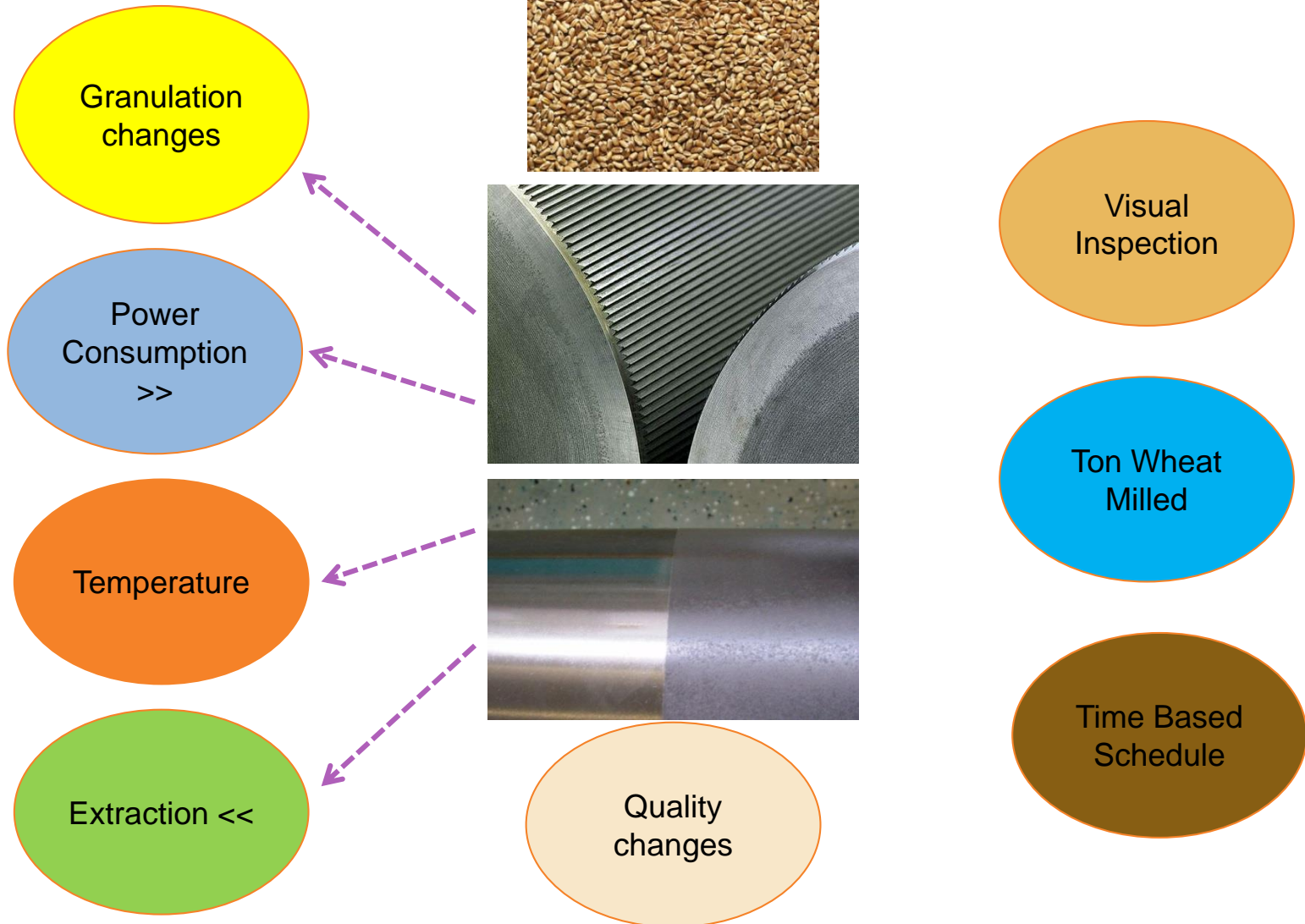

Knowing deeper ... our milling process, maintenance and reliability



NASA's Space Shuttles: Maintenance & Reliability are the Critical Success Factors

Where Our Values Created in Flour Milling Plant



Value Services & Solutions

Overview of a flour production plant

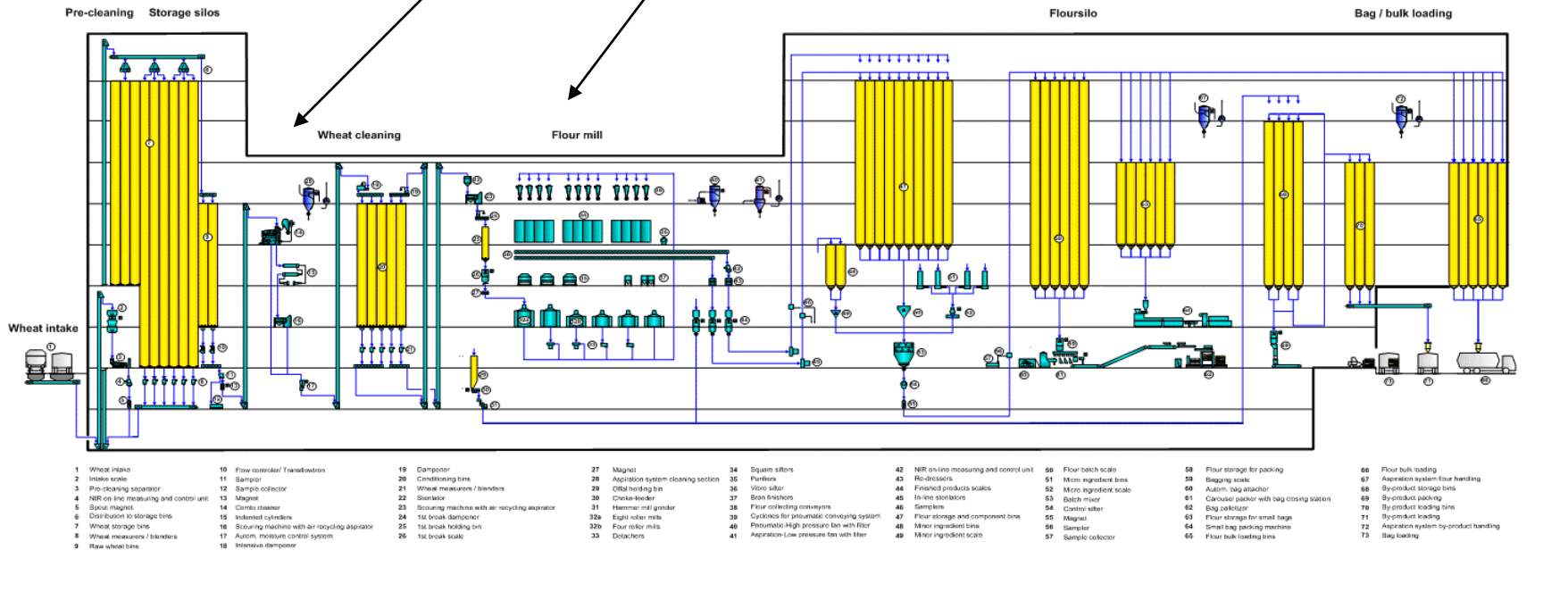

Our Professional Technologist & Service Engineers

- Professional Head Miller in local region, with strong support from Senior Head of Technologist in Singapore and Uzwil.
- Professional Sortex Service Engineer in local region, with strong support from Centre of Competence in Thailand.
- Professional Automation Engineer in local region, with strong support from Centre of Competence in China, Uzwil and Praha.
- Professional Electrical & Mechanical Engineer in local region.
- Professional Packing Engineer in local region with strong support from Uzwil
- Professional Site Erector in local region to support installation jobs.



TotalCare

... highest level of support...

1. WearCare - Preventative Maintenance
2. RepairCare – zero break down spirit
3. EjectorCare – service, fit & adjust

.... Parts & Services...



Roll service solutions from A-Z.

- Check-up on site
- Regrinding & Recorrugating
- Service and stocks
- Maintenance training



Roll detector

Roll detector is an analytic tool to detect the roll profiles. It measures wear out and derive economical statement as energy consumption, granulation, ash distribution. It will help the customer to control the energy consumption, product quality and yield.

South East Asia - Oceania Commitment

New Service Stations and Customer Service offices have been developing to serve best customers in region.

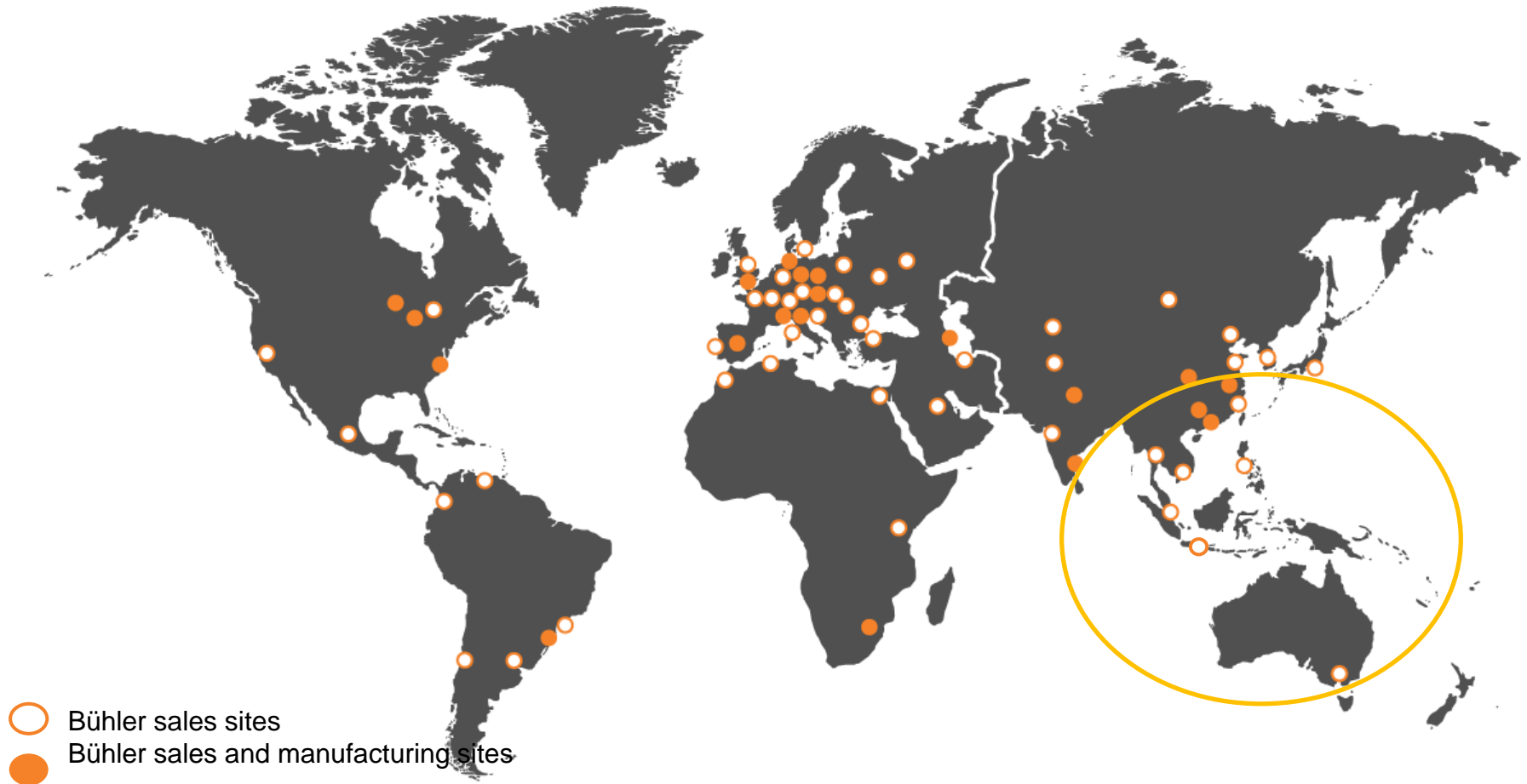

7 Service Stations in South East Asia - Oceania

Customer service set-up.

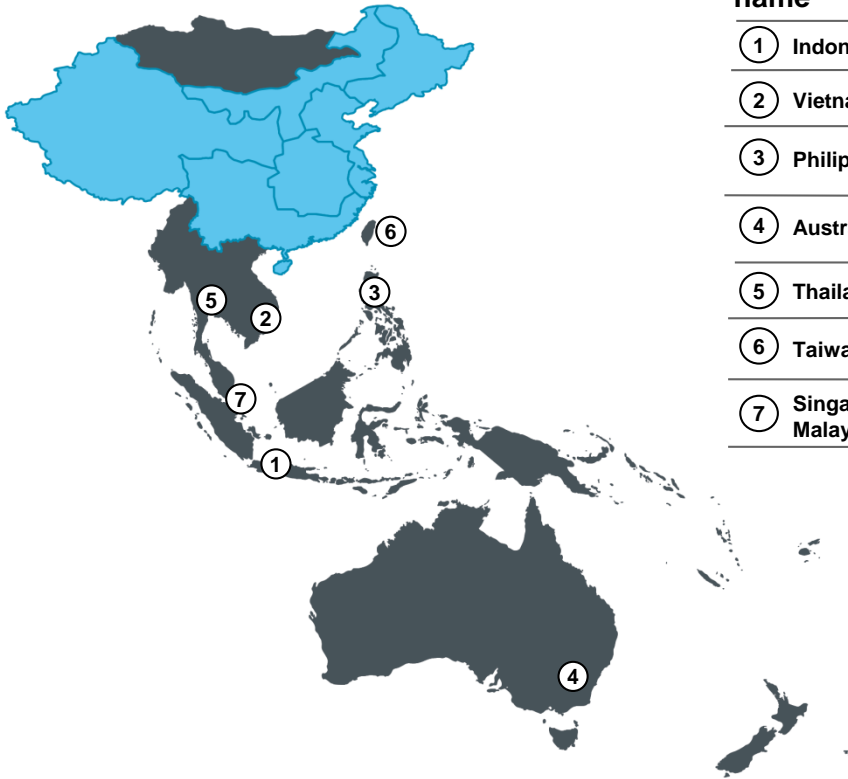

Service Stations				
Service Station name	Service contact location	Service engineers	Local stock	Workshop facility
① Indonesia	<i>Jakarta</i>	X	X	Jakarta & Surabaya
② Vietnam	<i>Hoh Chi Minh</i>	X	X	<i>Hoh Chi Minh</i>
③ Philippine	<i>Manila</i>	X	X	Manila
④ Australia	<i>Melbourne</i>	X	X	Sydney
⑤ Thailand/ Laos	<i>Bangkok</i>	X	X	Bangkok & Saraburi
⑥ Taiwan	<i>Taipeh</i>	X	X	Hsinchu
⑦ Singapore/ Malaysia/ Brunei	<i>Singapore</i>	X	X	

Getting closer.....

supporting best

Valuable Customers.

7 Service Stations in South East Asia - Oceania

Customer service set-up.



Thailand
Color Sorter Centre
(Roll Service)



Phillipine
Pasta & Extrusion Centre
Roll Service



Taiwan
Optic Centre



Singapore
Head Miller Centre



Vietnam
Roll Service
Rice Application Centre



Indonesia
Roll Service
Installation Service



Australia
Roll Service

... ready to support ...

- Installation – Start Up
- Roll performance
- Spare parts inventory
- Sortex – Total Care
- Auxiliary parts
- Training & Courses

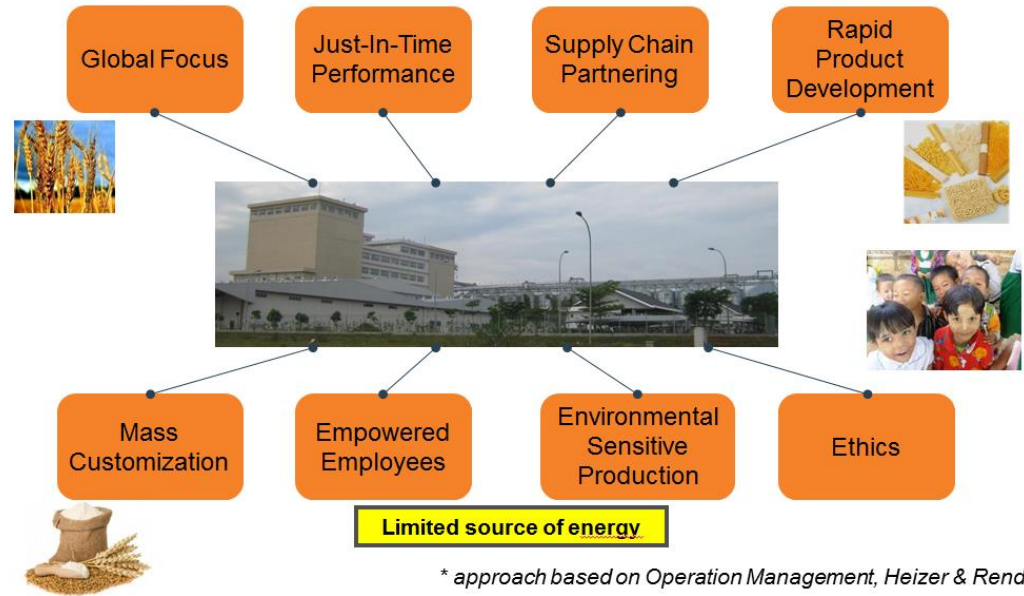

Customer Service

... added values Solutions ...

Master-Plan

Your vision – your Master-Plan



Expertise



Technology



Mid - Term

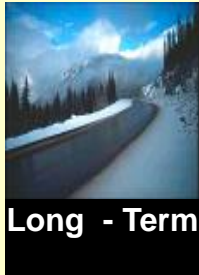

Long - Term

SOLIX.™

Profit optimization for existing mills



Expertise



Technology



Execution



Start up

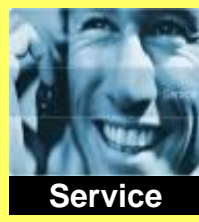

Service

Technology consulting

Assess plant requirements / Service



Plant inspection

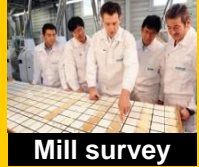

Mill survey



Action Plan



Follow up

Energy Saving

Energy Consulting



Reduce loss



Latest technology



Optimize Process

Plant Service

Mechanical; Electrical; Technology



Roller mill



Plansifter



scales/flow balancer



Mill control

www.buhlergroup.com