



IAOM Inaugural South Asia Region Meetings
Delhi, India: December 3-4 2018
Bangalore, India: December 6-7, 2018

Wheat Cleaning

Sunil Maheshwari
Siemer Milling Company
Teutopolis, Illinois



Targets of the Cleaning Section

1st Cleaning Section

- ❖ Blending of Wheat (for consistency in finished product)
- ❖ Removal of Coarse Impurities
- ❖ Removal of Dust
- ❖ Removal of Ferrous Metals
- ❖ Removal of Sand and Fine Particles
- ❖ Removal of Stones
- ❖ Removal of Husk and Light Particles
- ❖ Removal of Long and Round Particles
- ❖ Surface Treatment for Bacteria Count Reduction
- ❖ Moisture Measurement
- ❖ Removal of Non-Wheat Material
- ❖ Removal of Wheat not Suited for Milling

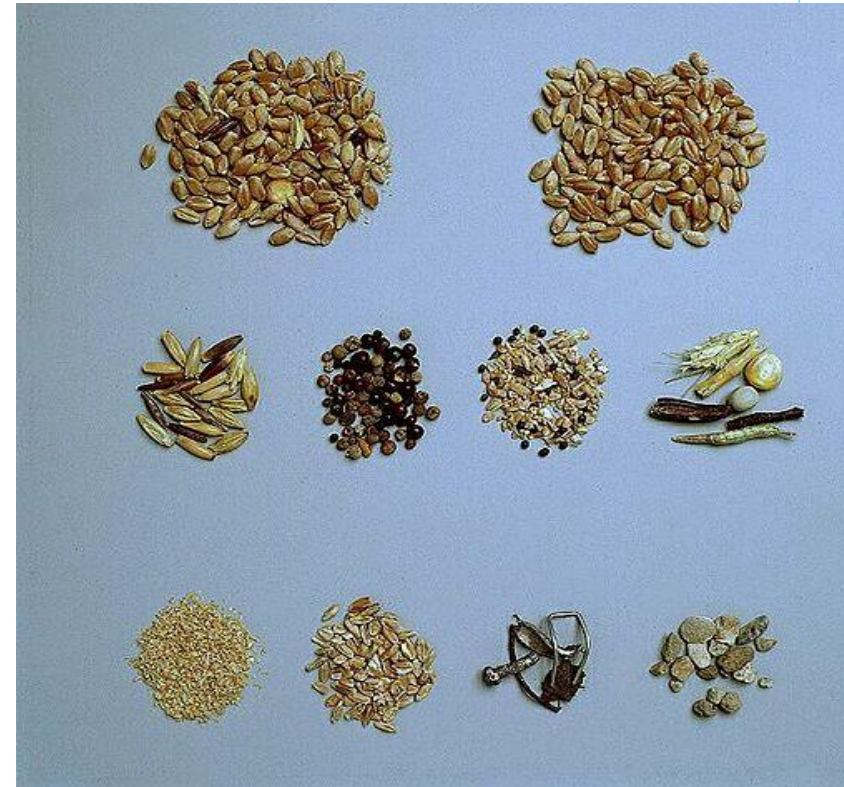



Targets of the Cleaning Section

2nd Cleaning Section

- ❖ Tempering (addition of water to condition wheat for grinding > 14.5%)
- ❖ Additional Surface Treatment
 - Scouring (Regular or Intensive)
 - Peeling (Light Peeling or Peeling)
 - Pearling (De-Branning, Typically used in Durum Milling)



Hard / Soft / Durum Wheats

Wheat Cleaning Requirements

Soft Wheat



Special Cleaning House Requirements:

- ❖ Removal of Foreign Seeds (Corn, Soy, Smell,)
- ❖ Vomitoxin Infestation (Surface Treatment, Impacting, Aspiration)
- ❖ Only Short Temper Required due to Soft Kernel Structure

Hard / Soft / Durum Wheats

Wheat Cleaning Requirements

Hard Wheat



Special Cleaning House Requirements:

- ❖ Removal of Foreign Seeds (Corn, Soy...)
- ❖ Medium Temper Time Required - 12 - 24 hours
Recommended
- ❖ Additional Surface Treatments Required for Low Bacteria Counts (Peeling)

Hard / Soft / Durum Wheats

Wheat Cleaning Requirements

Durum Wheat



Special Cleaning House Requirements:

- ❖ Removal of Foreign Seeds
 - ❖ (Specs in Coarse Finished Product Semolina)
- ❖ Removal of Stones
- ❖ Long Temper Time Required - 24 - 48 hours Recommended
- ❖ Peeling and /or De-Branning in Cleaning House Prior to Mill



Cleaning House Designed According to Application / Requirements

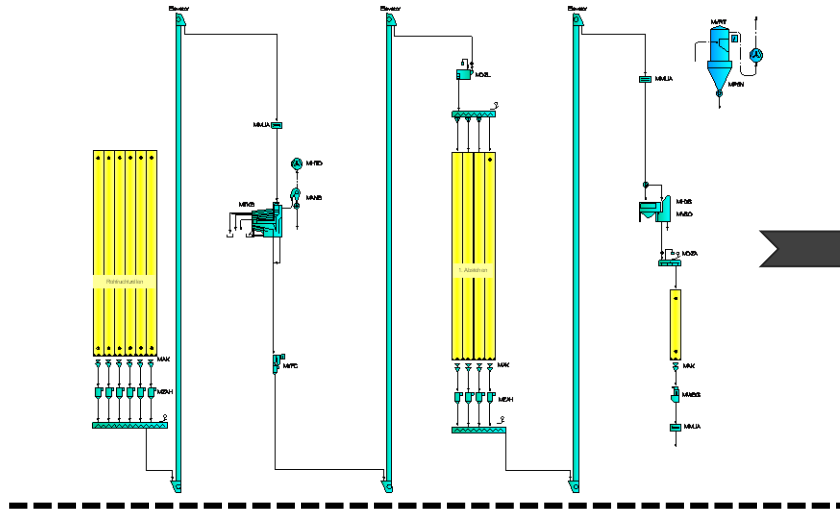

Simple Cleaning Section Flow Sheet

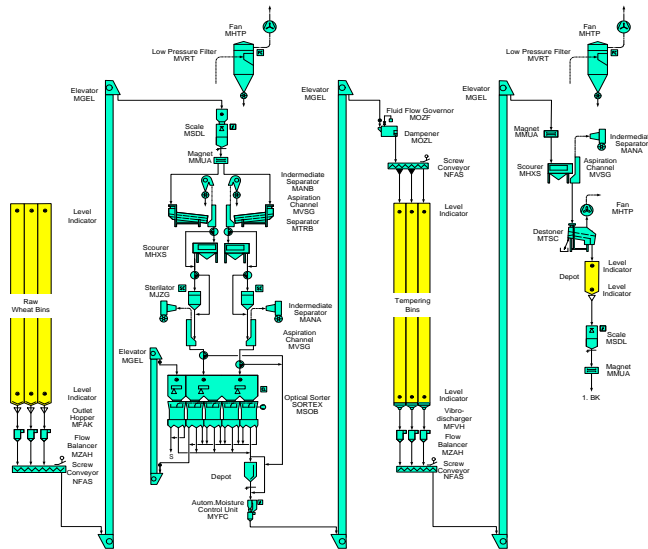

High Standard Cleaning Section Flow Sheet



Wheat Blending - Transflowtron

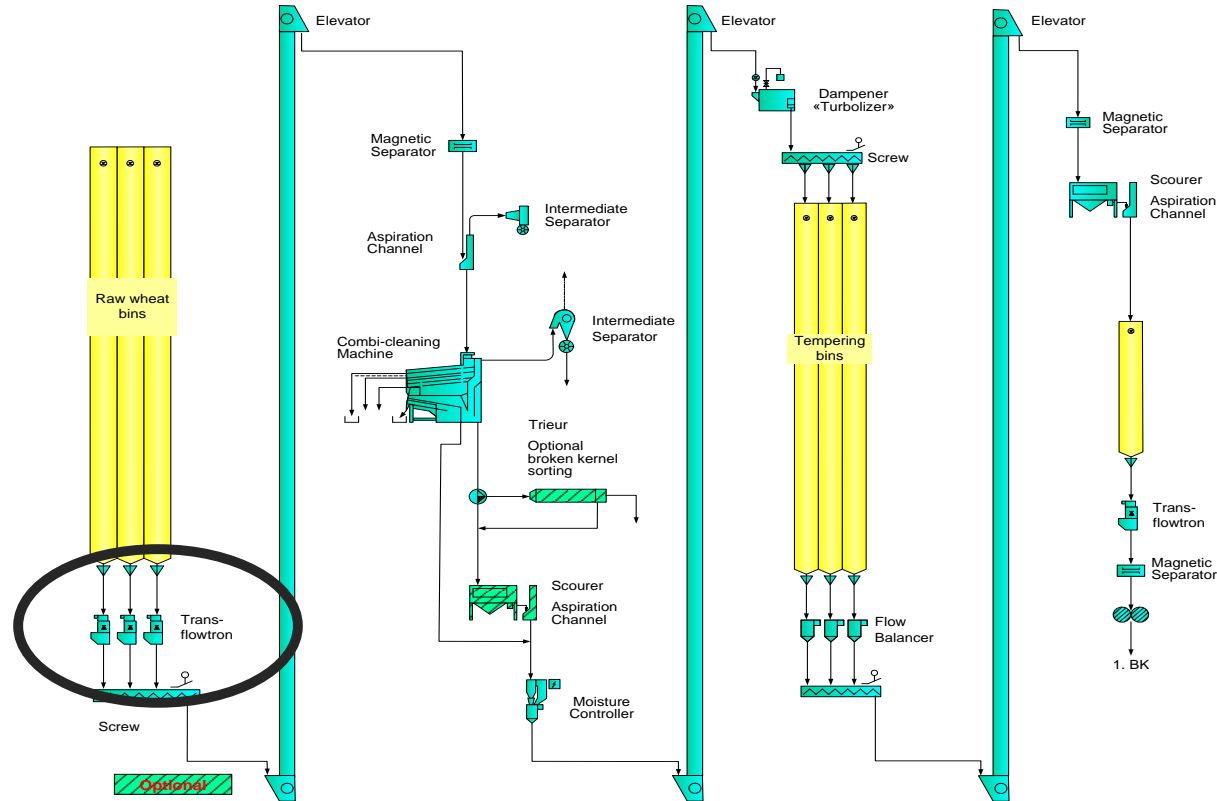

Factors for Blending of Wheat

- ❖ Adjustment of the Protein Content of the Flour
- ❖ Adjustment of the Gluten Characteristics of the Flour
- ❖ Adjustment of the Price of the Wheat Mixture
- ❖ Production of Appropriate Flour Quality for the End User

Equipment for Blending of Wheat



Flowbalancer

- ❖ Gravimetric Discharge
- ❖ Fair Accuracy $\pm 1-4\%$
- ❖ Low Built-in Height
- ❖ Cost Efficient Solution
- ❖ Limited Traceability
- ❖ Limited Usage for Silo Stock Control



Transflowtron

- ❖ Gravimetric Discharge
- ❖ Scale Accuracy $\pm 0.25\%$
- ❖ Ideal for Silo Stock Control
- ❖ Ideal for Traceability
- ❖ Minimum Build-in Height Required



Wheat Cleaning System Traditional Design

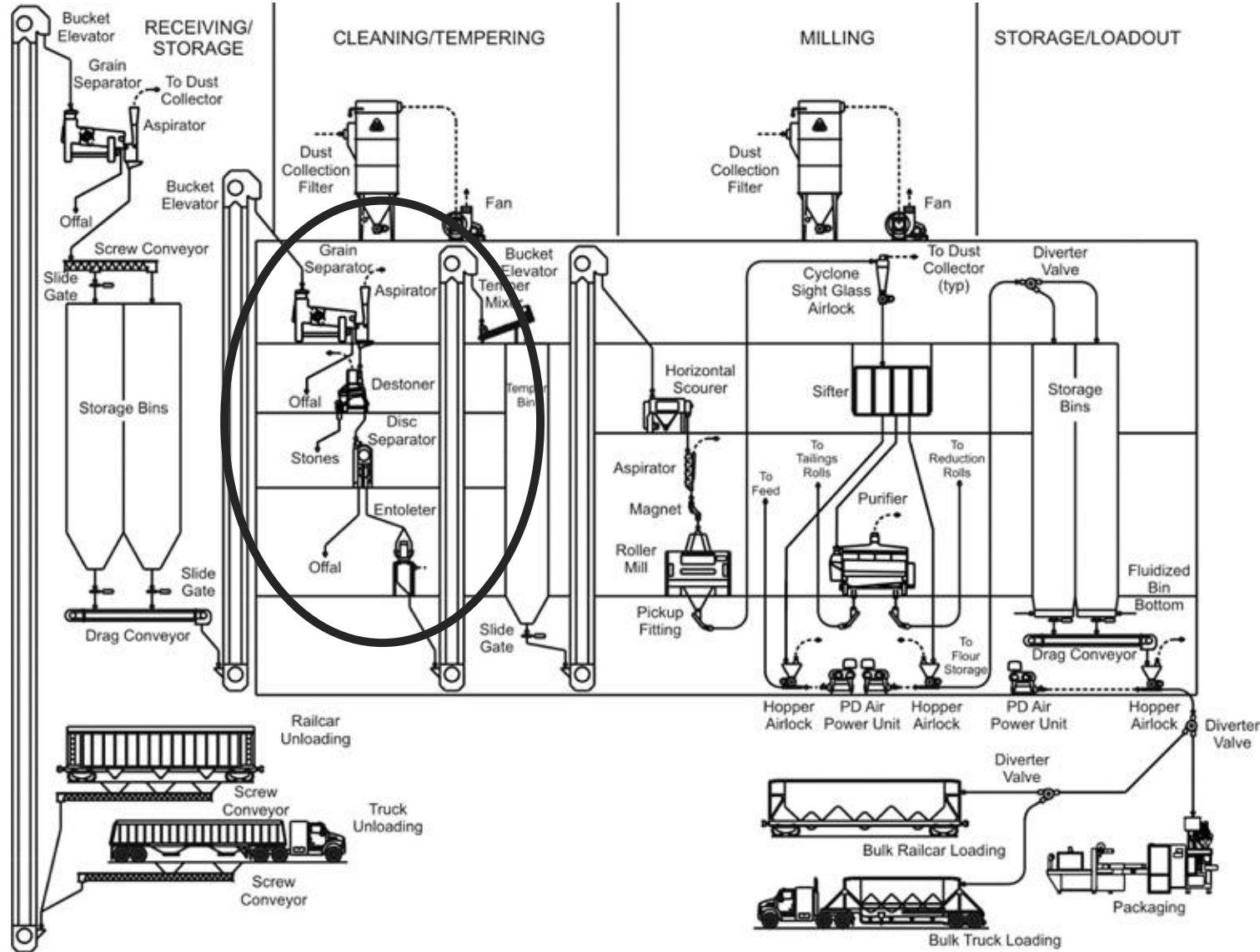

Wheat Cleaning System Milling Separator

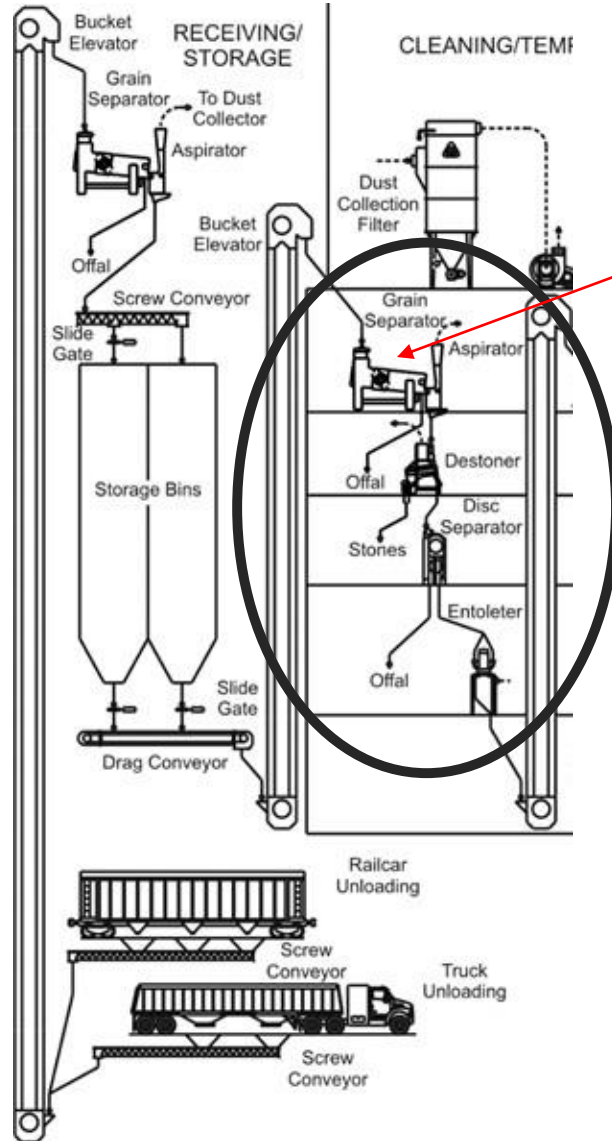

- ❖ Separation Based on Particle Size
- ❖ Consists of Several Sieves
- ❖ May be Combined with Aspirator Sections

Wheat Cleaning System Aspirator

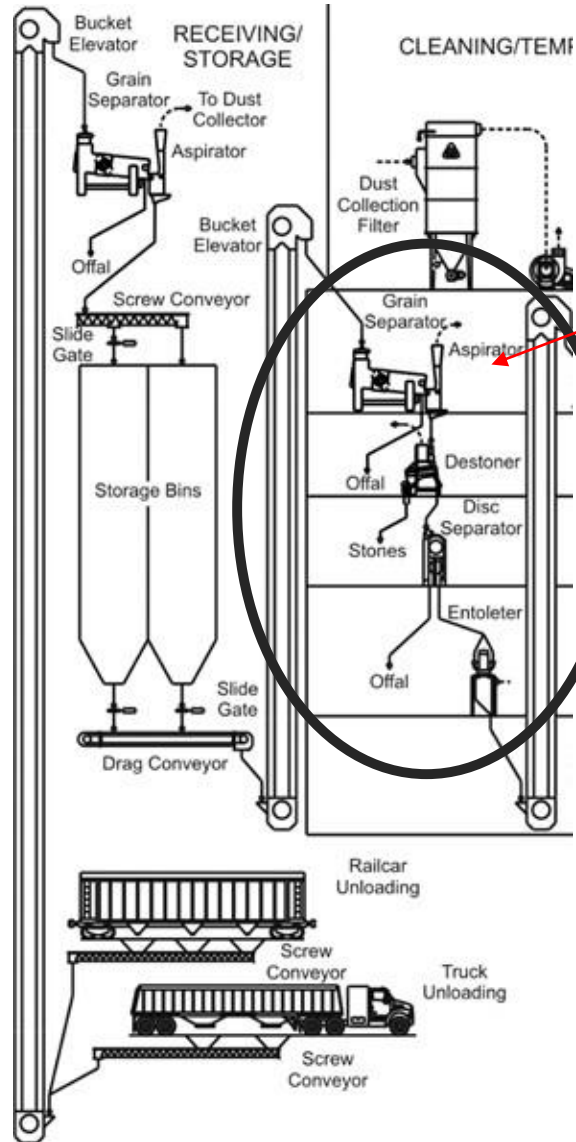

- ❖ Remove Light Materials
 - ❖ Shriveled Grains of Wheat
 - ❖ Chaff
 - ❖ Joints of Straw
 - ❖ Dust
- ❖ Remove Scourings
 - ❖ Crease Dirt
 - ❖ Bran Particles
- ❖ Separate Infested Grain
- ❖ Mildest Form of Wheat Cleaning



Wheat Cleaning System Destoner

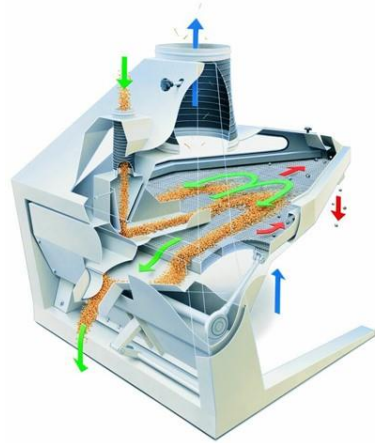

- ❖ Eliminate Heavy Impurities such as Stones
- ❖ Design offers less flexibility than the gravity separator and requires more fine-tuning.
- ❖ Separates the material into four groups by density:
 - ❖ Stones and other Heavy Impurities
 - ❖ Whole Clean Grain
 - ❖ Low Density and Damaged Kernels
 - ❖ Dust

The volume of air and the inclination of the deck can be adjusted to suit the grain characteristics and the degree of separation required.

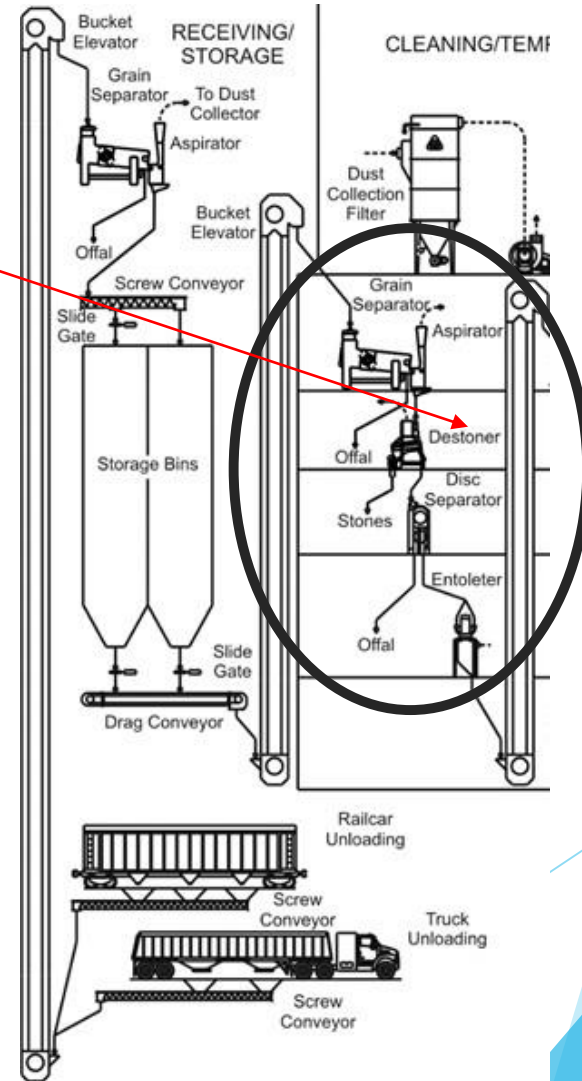

Wheat Cleaning System

Disc Separator

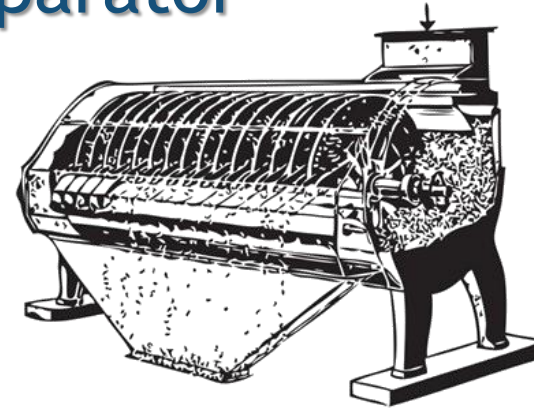
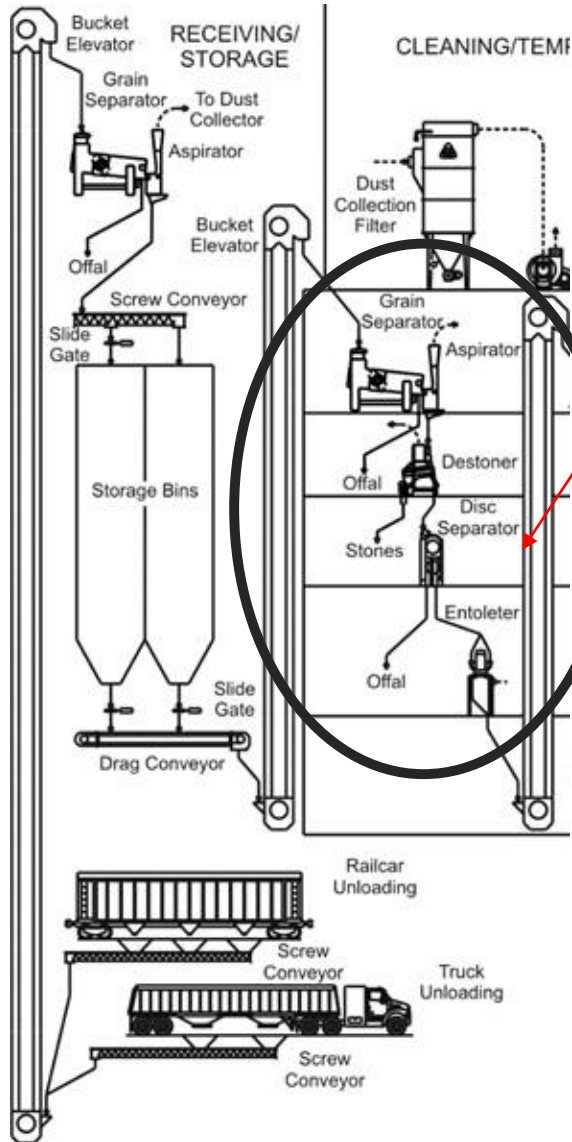

- ❖ Uses the same principles as the cylinder separator, but instead of one, long cylinder, uses a series of indented, hardened discs.
- ❖ Typically handles a higher capacity than a cylinder separator.
- ❖ More efficient and flexible machine than the cylinder separator.
- ❖ The wheat is picked up in hundreds of indentations that are designed to pick up and discharge small particles.
- ❖ Impurities will be conveyed to the tail end of the machine and discharged into the screenings stream.

Wheat Cleaning System Entoleter

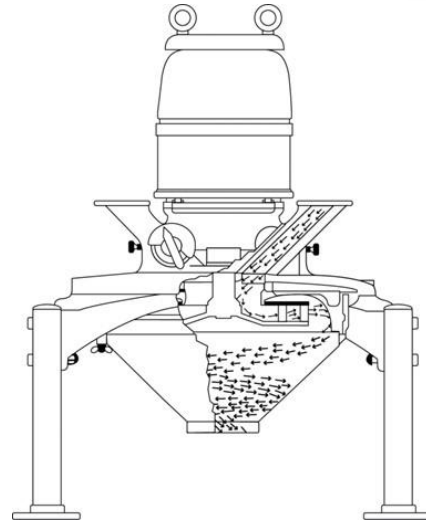

- ❖ High-speed Rotor followed by an Aspirator.
 - ❖ Whole grain enters the top of the machine through an inlet and passes by gravity to the spinning rotor. Centrifugal forces throw the grain against an impact ring around the rotor. The impaction of grain against the ring loosens dust, chaff and kills insects which are removed by aspiration. The severity of the action can be controlled by the speed of the rotor, rotor design and impact ring configuration.
- Developed primarily for insect control but also used for grinding some middling stocks.

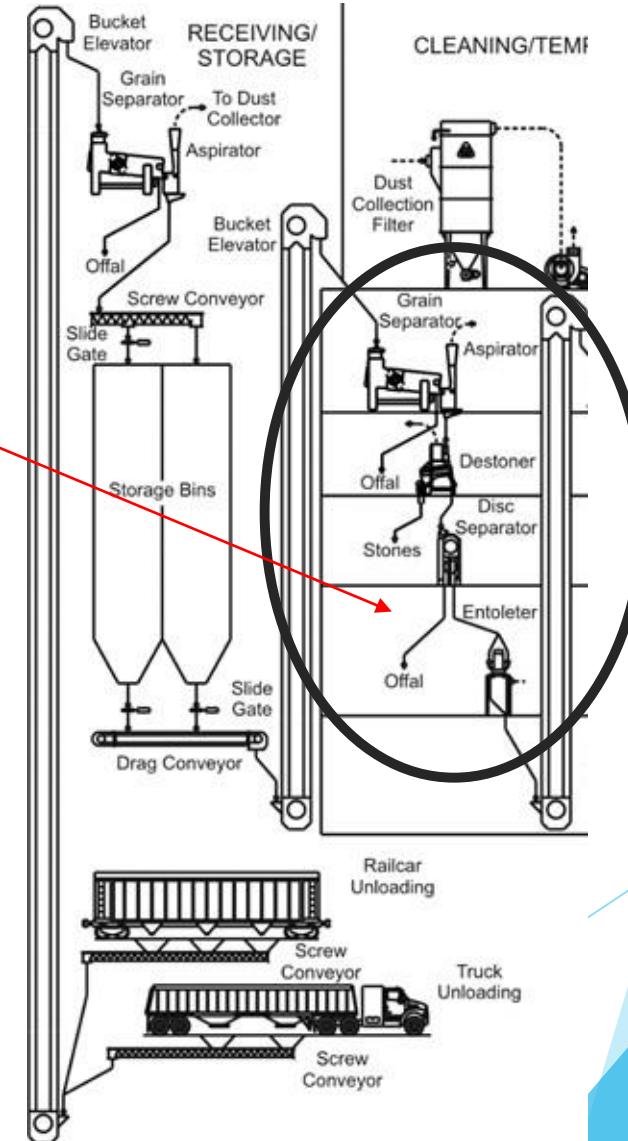



Wheat Cleaning System Combi-Cleaner

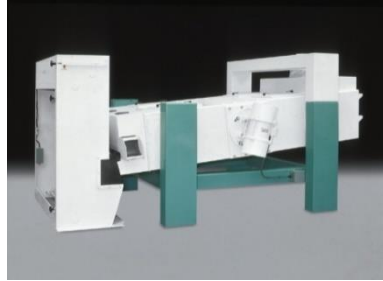

Separator with Aspiration Channel

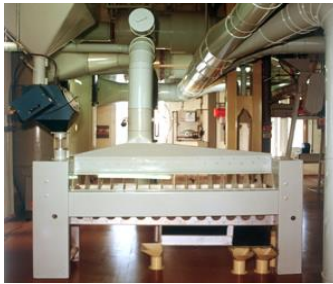

Concentrator



Destoner

The Combi-Cleaner was designed to combine the functions of several individual machines.





Combi-Cleaner - Fractions

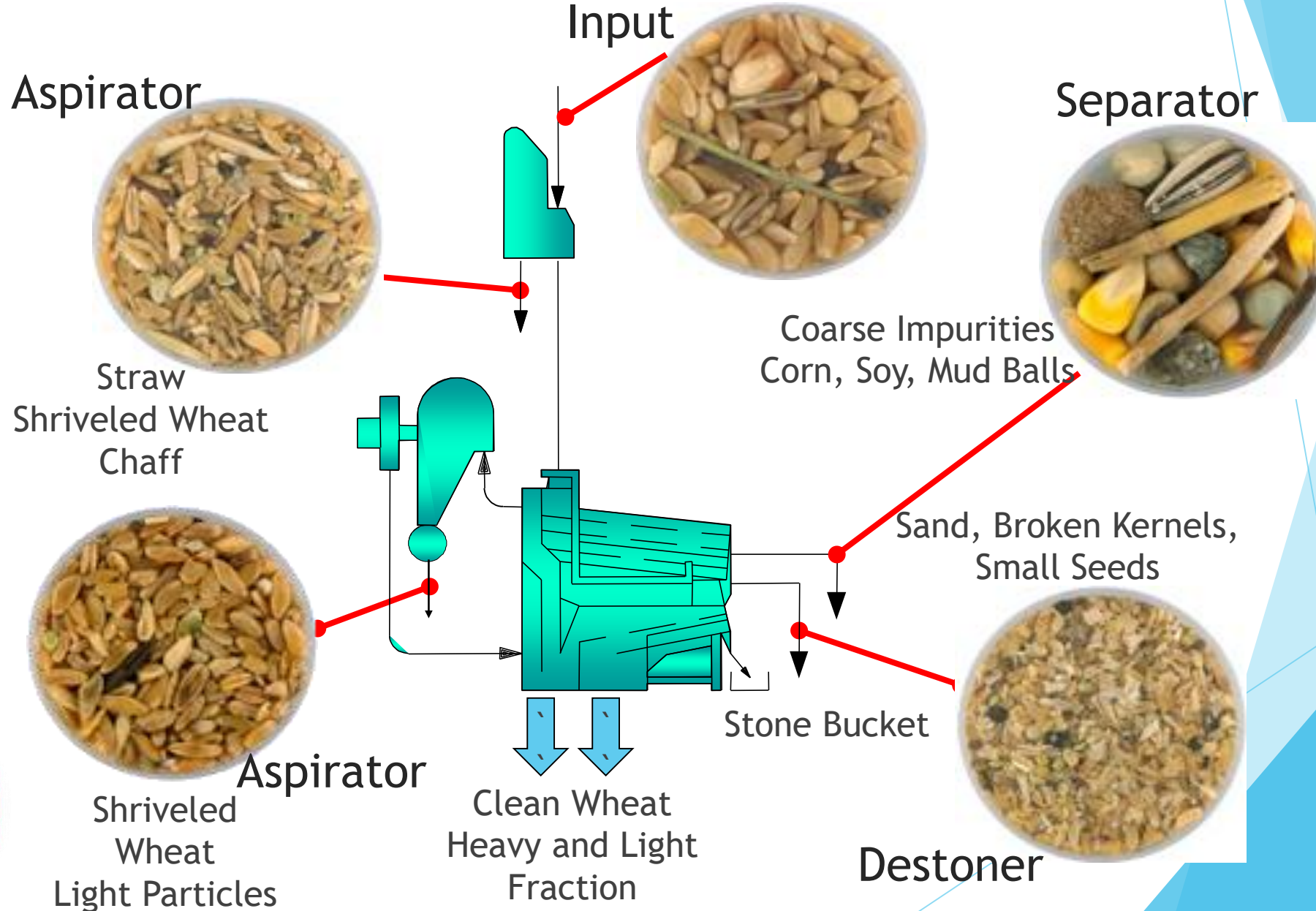

Wheat Cleaning System

System Design

- ❖ The **indented cylinder** removes round, long impurities or both and is important if a speckless flour is to be produced
- ❖ The **scourer** provides surface treatment and bacteria count reduction.
- ❖ The **scourer** is vital in the 2nd Cleaning, but for low bacteria counts a scourer should be used for the mixed product in the 1st Cleaning as well.

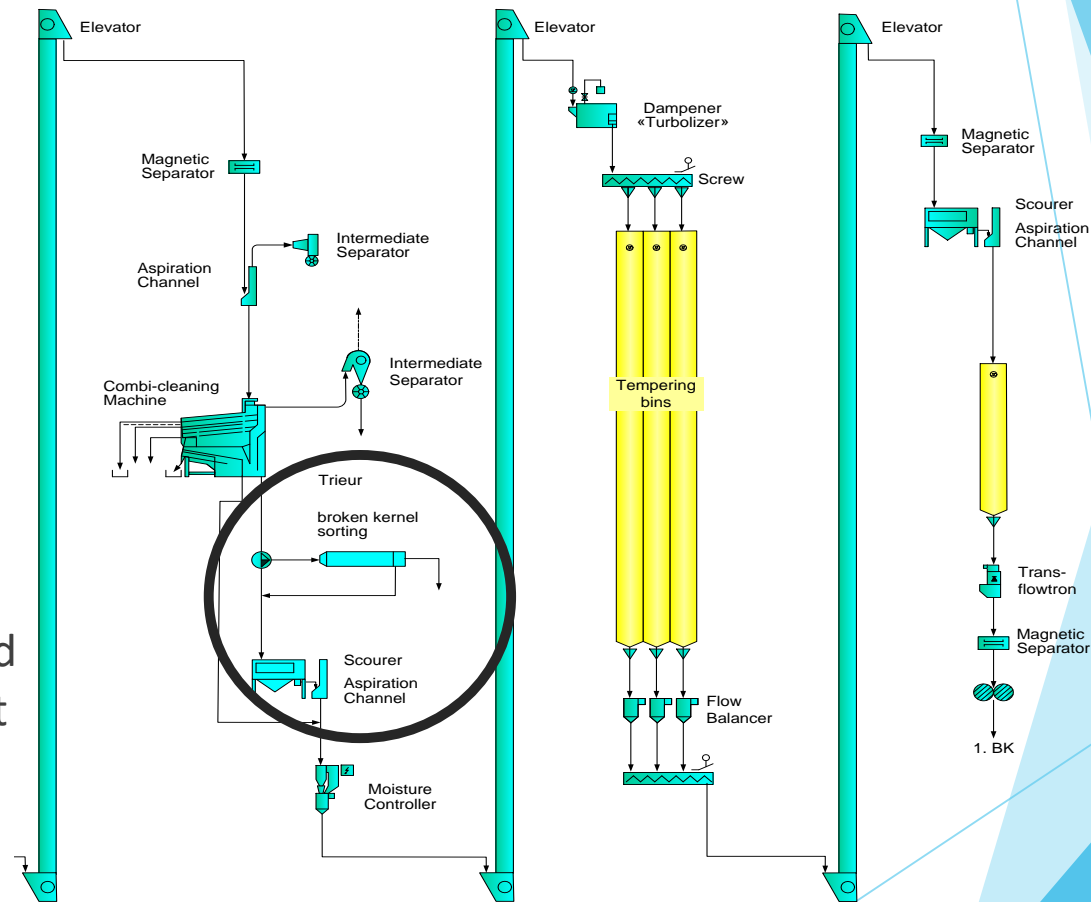

Indented Cylinder Disc Separator

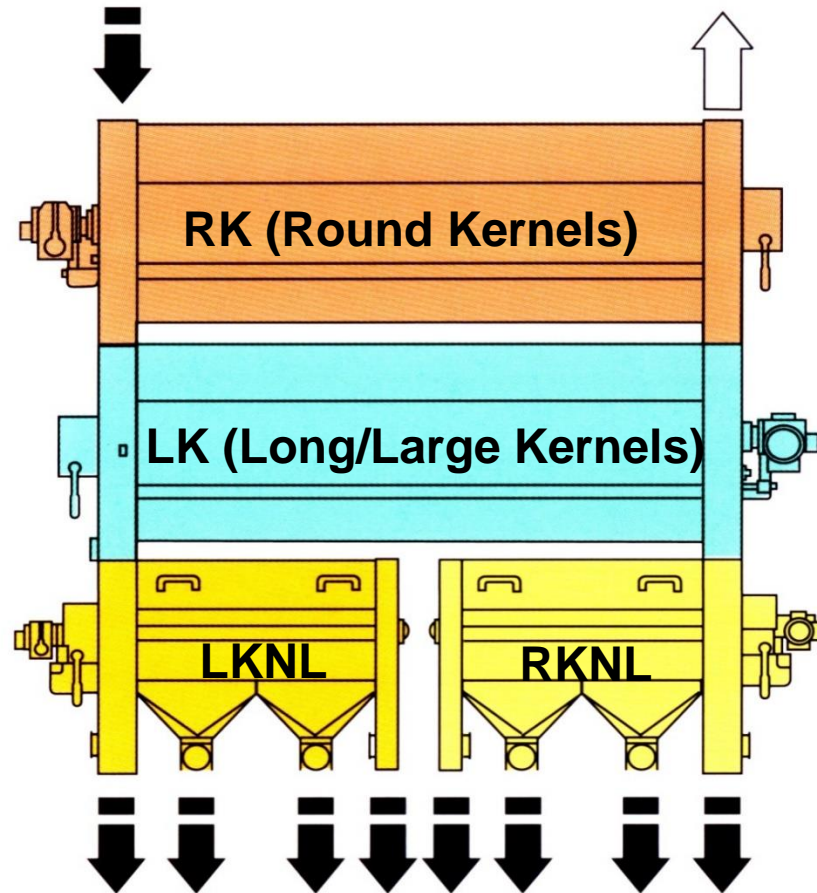

RKNL = Resorting Cylinder Round Kernels
LKNL = Resorting Long and Large Kernels

Indented Cylinder Working Principle

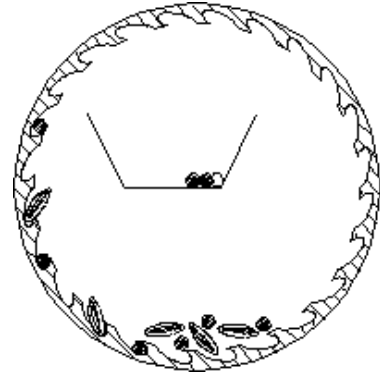

Shape Separation
Through Indents

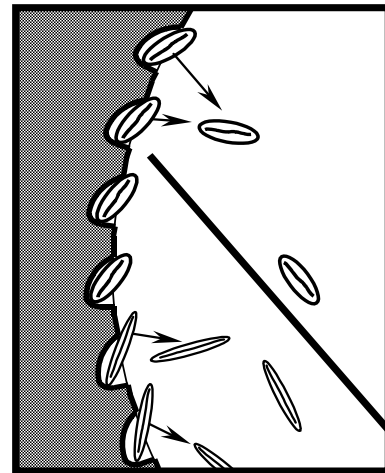
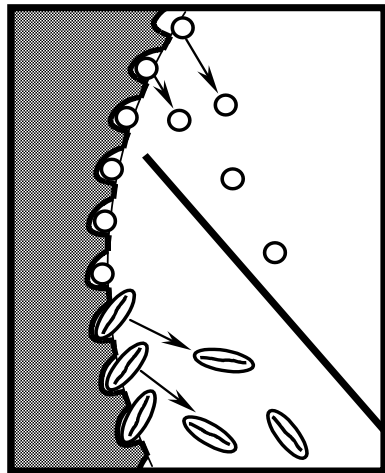
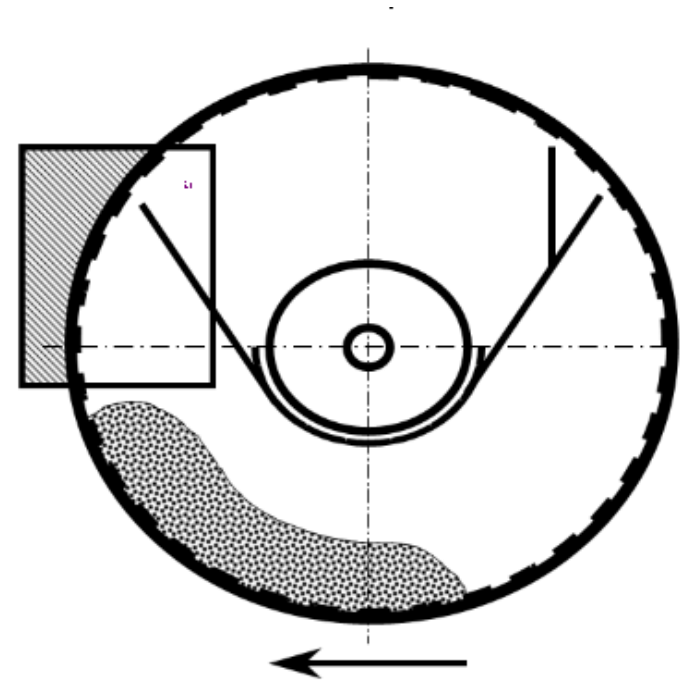



Wheat Cleaning System

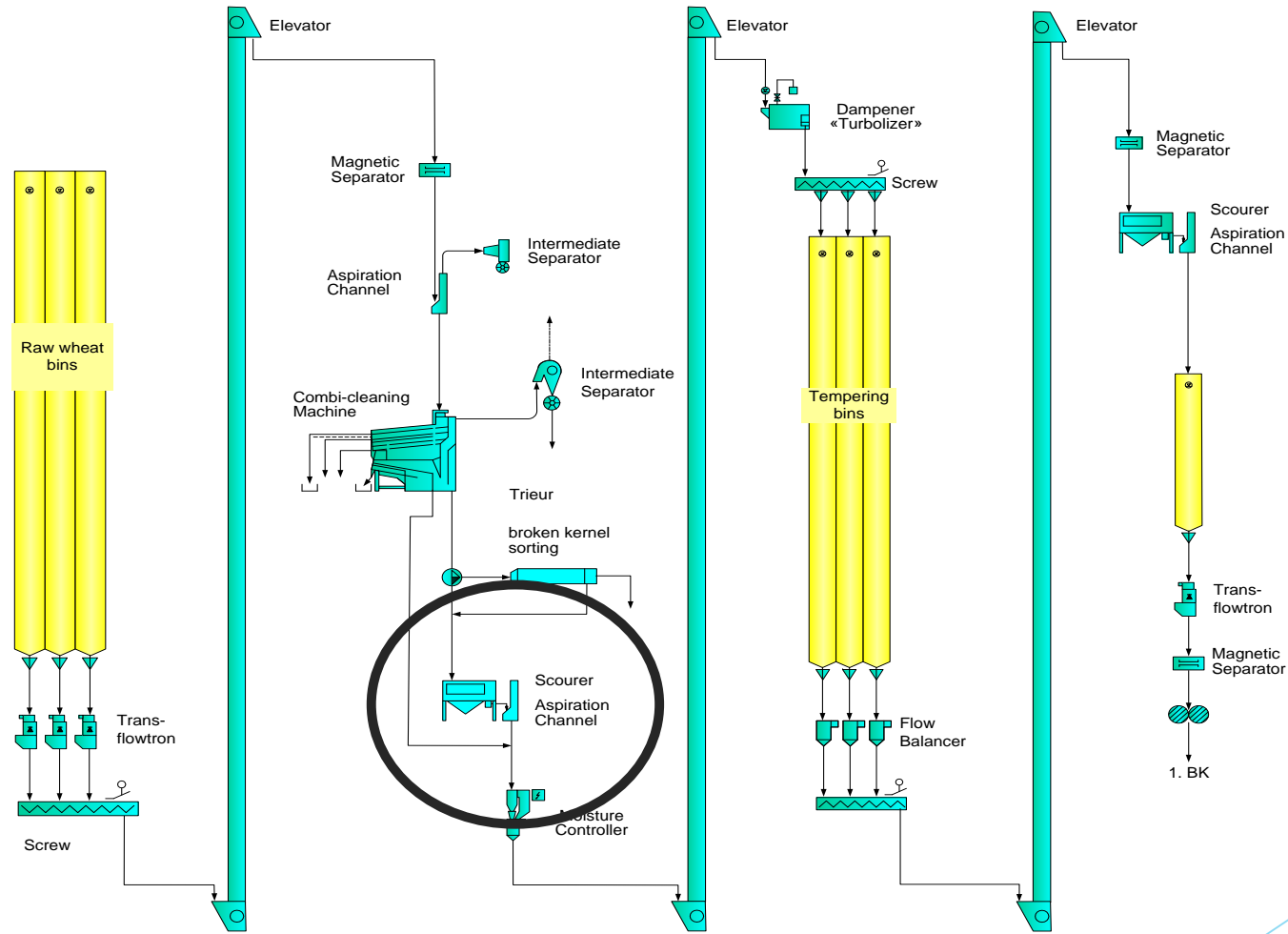

Scourer



Important: Aspiration
Channel after Scourer for
Removal of Remaining Dust

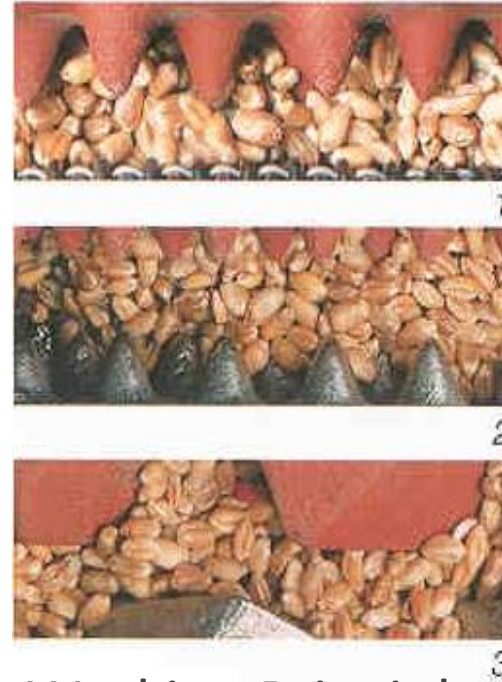

Working Principle

Friction of:

1. Grain against Screen
2. Grain against Rotor Segments
3. Grain against Grain

Scourer

Intensive Surface Treatment to Reduce Microbial Load (Yeast and Mold)

- ❖ Application prior to tempering to reduce microbial load prior to tempering.
- ❖ Usual application also in 2nd Cleaning for tempered product to clean surface and crease after water addition.
- ❖ For optimum microbiological load reduction also between 1st and 2nd tempering.
- ❖ For maximum microbiological load reduction peeling is necessary.

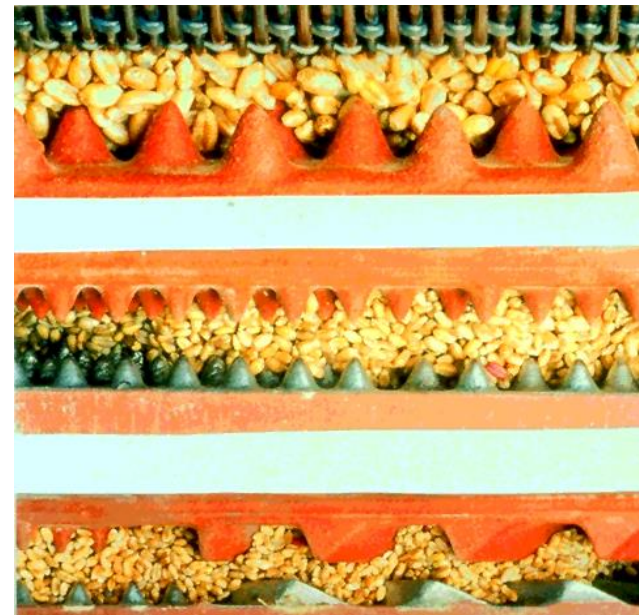



Wheat Cleaning System Conditioning System

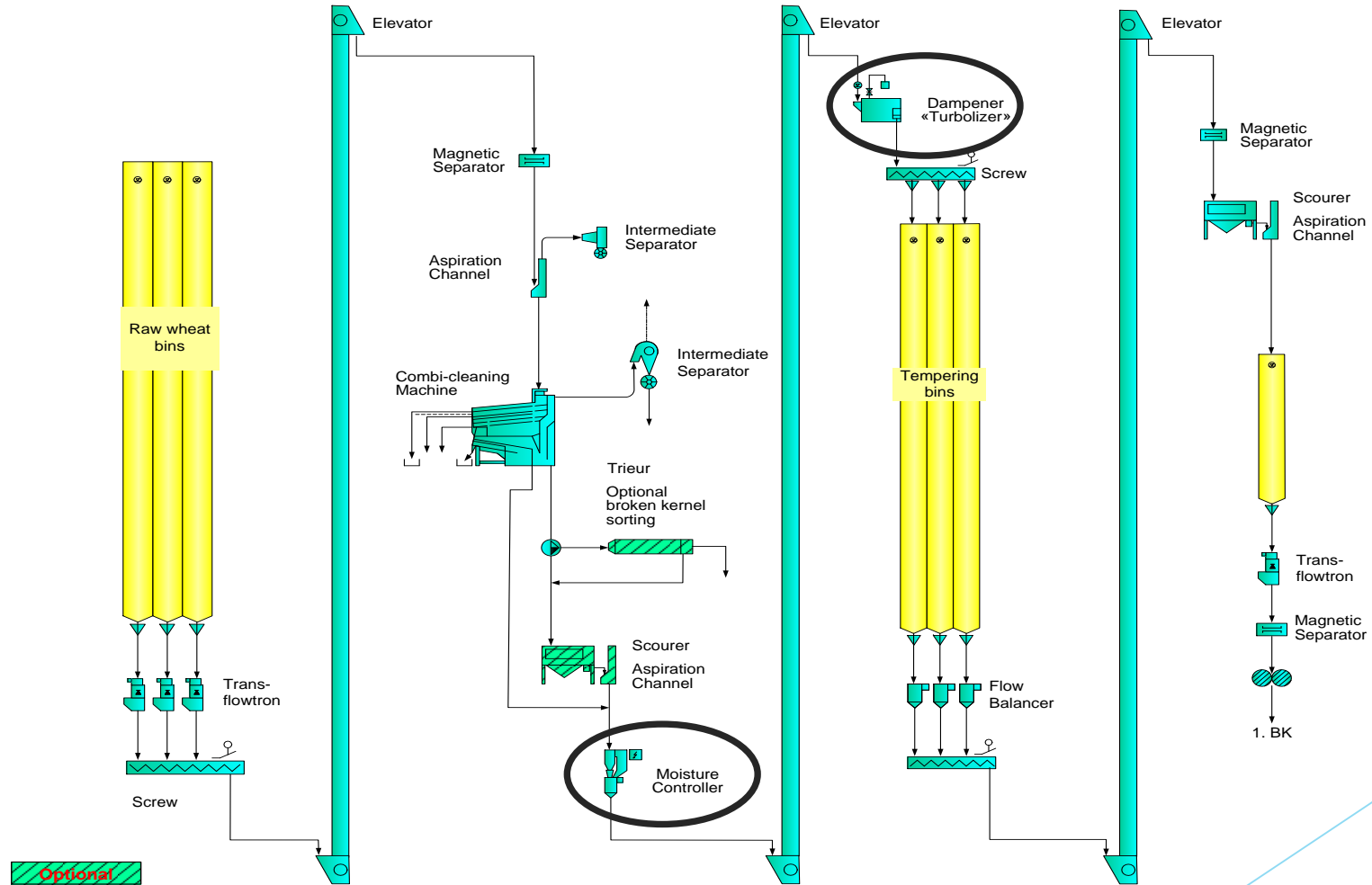



Wheat Conditioning

Adding Water to the Wheat

- ❖ Mellowing of the Endosperm
 - ❖ Flour Extraction can be Increased
 - ❖ Power Consumption / Noise Level of the Roller Mills Reduced
 - ❖ Flour Ash Content Reduced

- ❖ Toughening of the Bran
 - ❖ Bran tends to break up less and remains in bigger pieces.
 - ❖ Large bran flakes can effectively be cleaned by the fluted rolls.
 - ❖ Less Small Bran Specks in the Flour

- ❖ Adjustment of the Flour Moisture Content
 - ❖ Constant Moisture Level = Constant Milling Conditions
 - ❖ Constant Moisture Level = Constant Baking Conditions
 - ❖ Profitability for the Miller





Wheat Conditioning

Adding Water to the Wheat

Recommended Tempering Time		1st BK Moisture
Hard Wheat	24 - 36 (48) Hours	16.0 - 17.0% (17.5%)
Semi-hard Wheat	18 - 24 Hours	15.5 - 16.0%
Semi-soft Wheat	12 - 18 Hours	15.0 - 15.5%
Soft Wheat	6 - 12 Hours	14.5 - 15.0%

Maximum Moisture Content on 1st BK is Influenced by:

- ❖ Hardness of the Wheat
 - ❖ Energy Needed for Grinding and Moisture Loss
- ❖ Maximum Moisture Content of the Flour
 - ❖ Government or End User Specifications
- ❖ Maximum Moisture Content of the Bran
 - ❖ Storage Problems
- ❖ Operational Problems
 - ❖ Sifting Performance / Mold Development



Wheat Conditioning

Influence of Grain Hardness on Conditioning Time

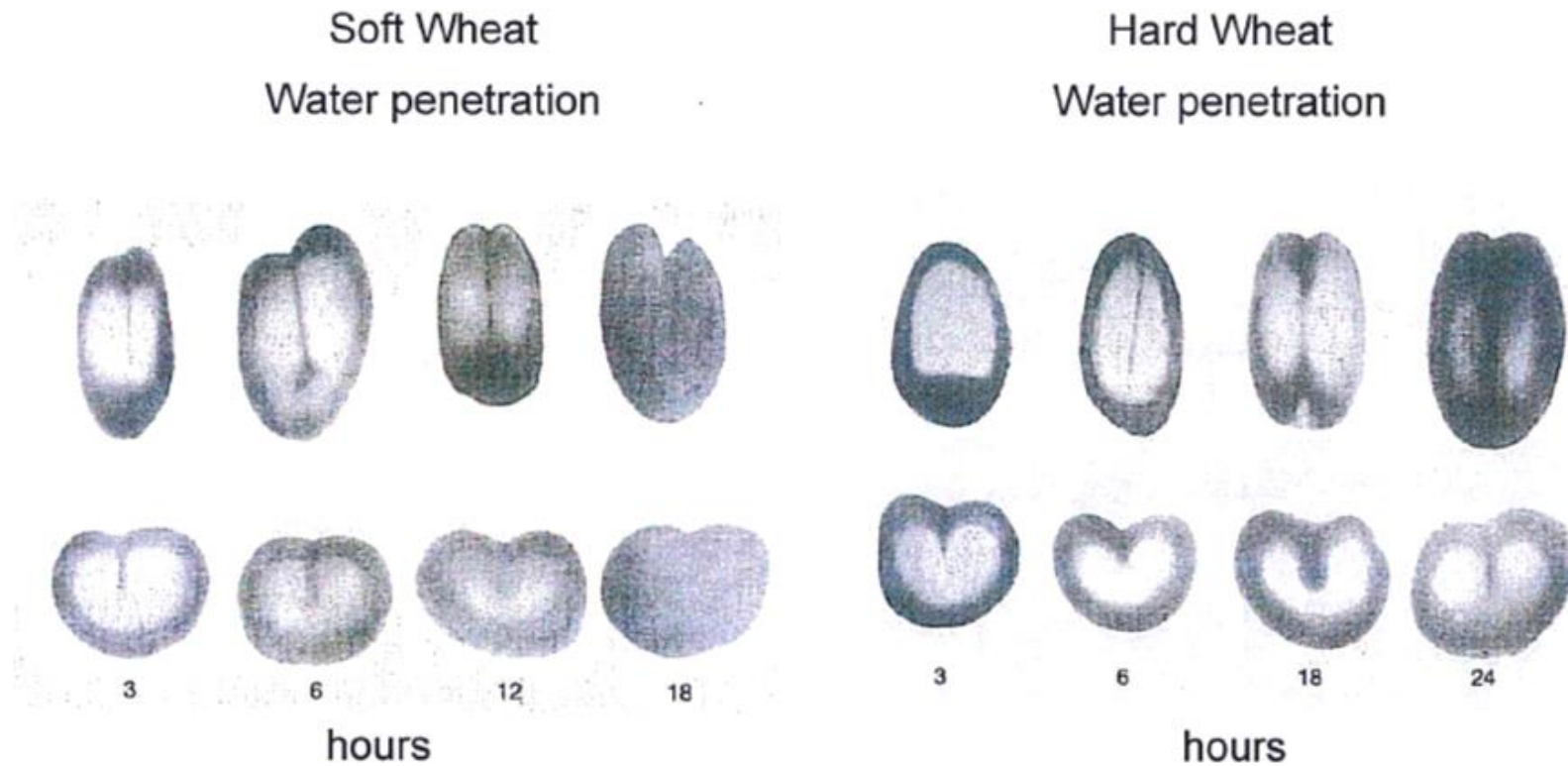



Wheat Cleaning System

Moisture Control/Intensive Dampening

Automatic Moisture
Measurement and Control



Automatic Water Proportioning

Intensive Dampener



- ❖ Automatic Moisture Measurement
- ❖ Re-adjustment of Moisture Content
- ❖ Intensive Mixing of Grain for Optimum Water Distribution





Latest Cleaning House Concept

All Wheat Varieties - High Cleaning Standards

Vomitoxin in Soft Wheat

Grain Cleaner

- ❖ Saving of Building Space
- ❖ Larger Sieve Area
- ❖ Circular Motion

Optical Sorting

- ❖ Water Cooling
- ❖ No Resort
- ❖ Tiered Chutes
- ❖ Max. 4 t/h per Chute

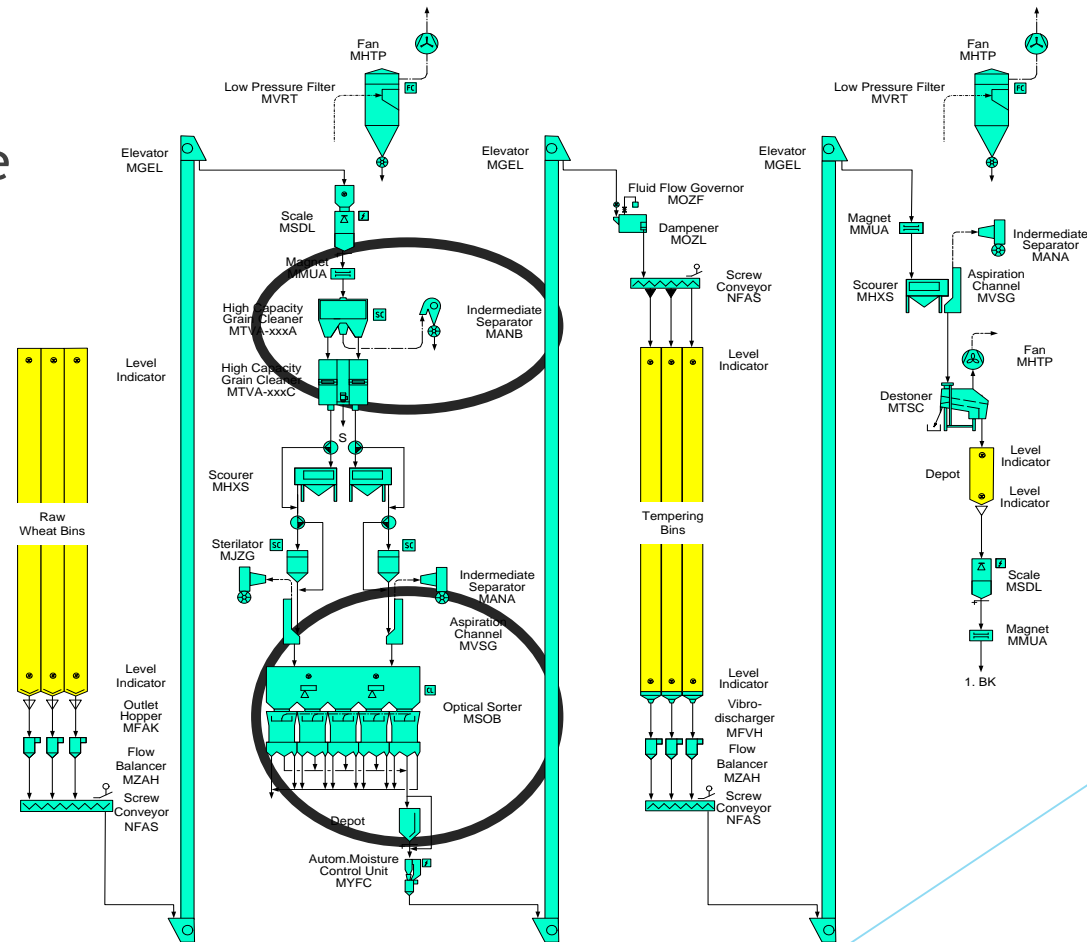

High - Capacity Cleaner

Sieving Machine with:

- ❖ Aspirator
- ❖ Scalping Sieves
- ❖ Sand Sieves

Application:

- ❖ Transfer Line to the Raw Wheat Bins
- ❖ First Cleaning

Characteristics:

- ❖ Scalper at the Top for Large Material
- ❖ Sieves Remove Fines
- ❖ Very High Capacity Milling Separator - Makes better use of processing surface.

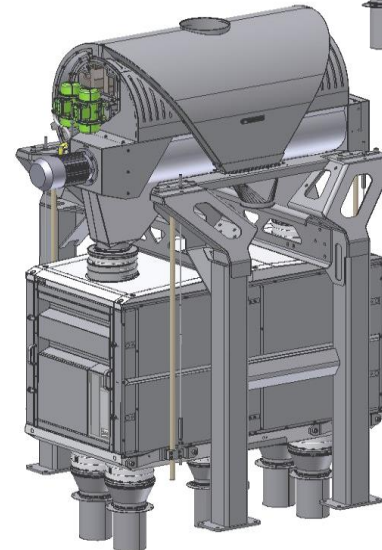
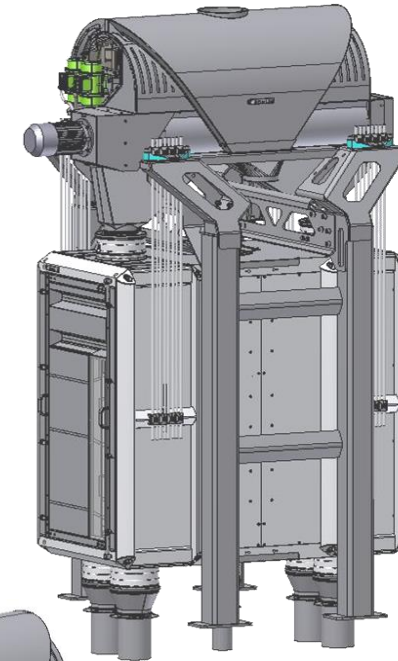
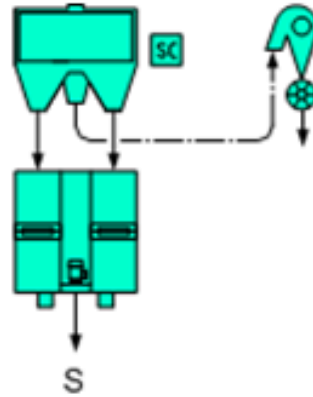

High Capacity Grain Cleaner Aspirator for Light Fraction

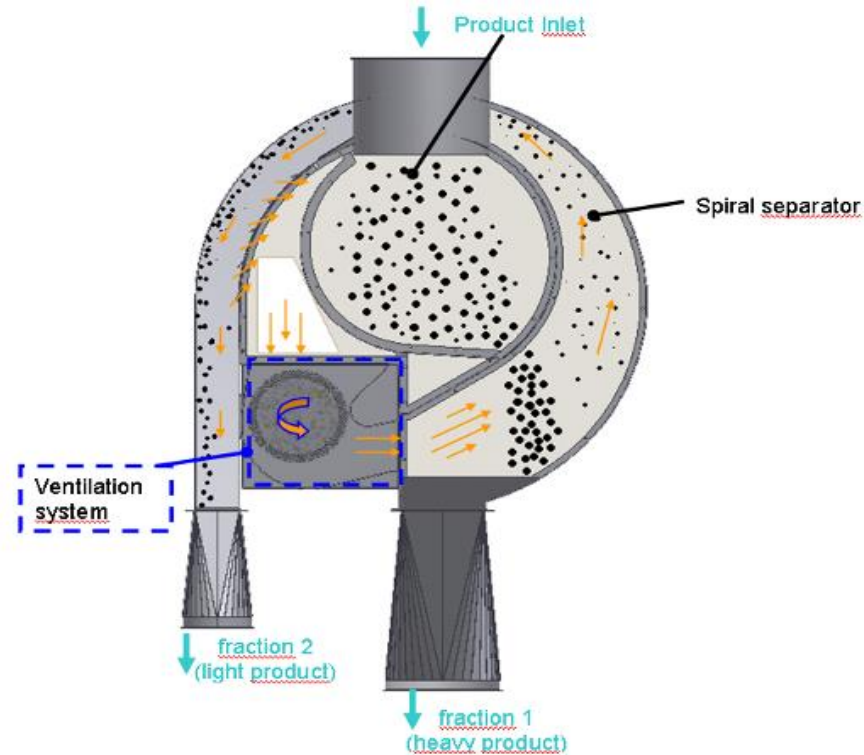

- ❖ Based on the Concept of a Recycling Air Separator
- ❖ Reduced Operational Costs and Increase of Economic Efficiency with 50% Lower Energy.
- ❖ Less Filter Load
- ❖ Less Installed Horse Power



High Capacity Grain Cleaner Sieve Module



- Horizontal Drawer System
- Flexible Sieve Stack
- Two Different Sieve Types
 - ❖ Scalping Sieve
 - ❖ Sand Sieve

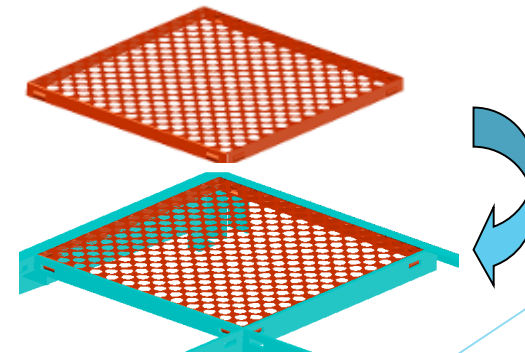



Optical Sorter



Discolored Germ



Seeds



Fungus Damage



Ergot

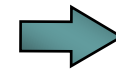

Working Principles Optical Sorter

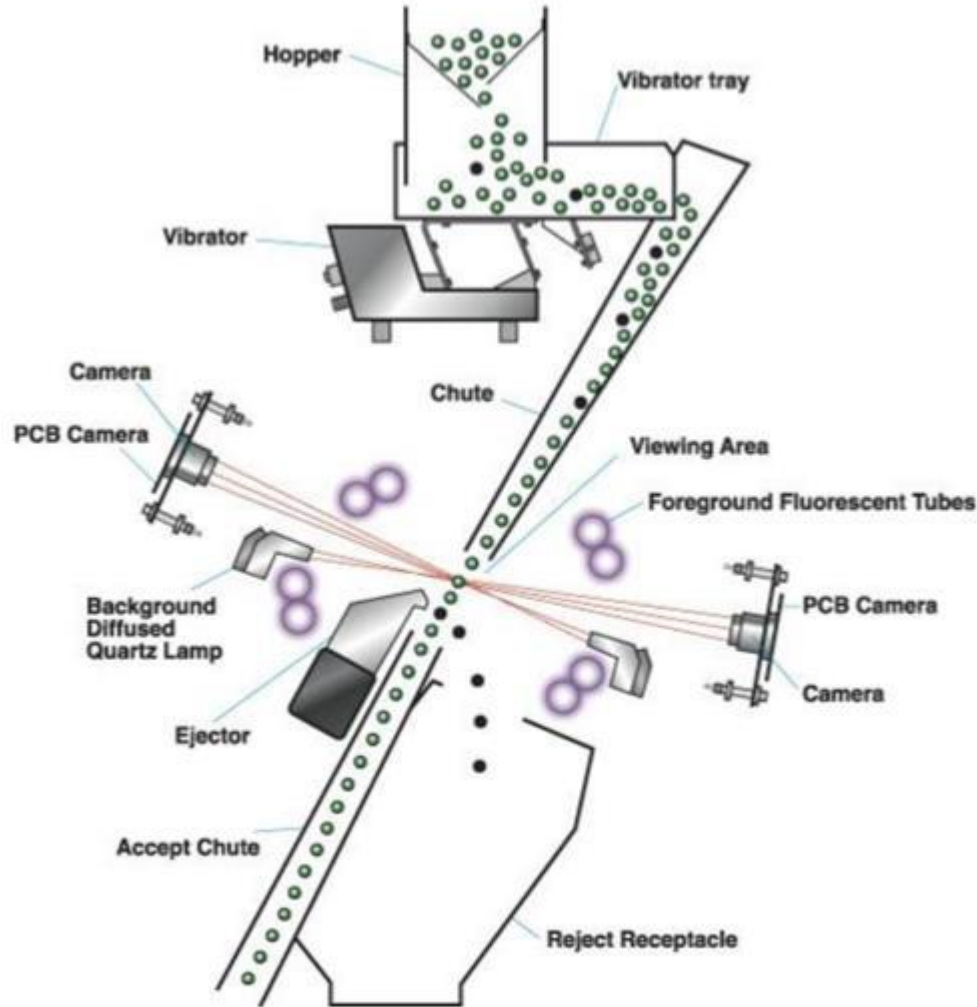

- ❖ Feed System
- ❖ Optical Inspection System
- ❖ Data Processing
- ❖ Ejection Mechanism

Optical Color Sorter Fractions

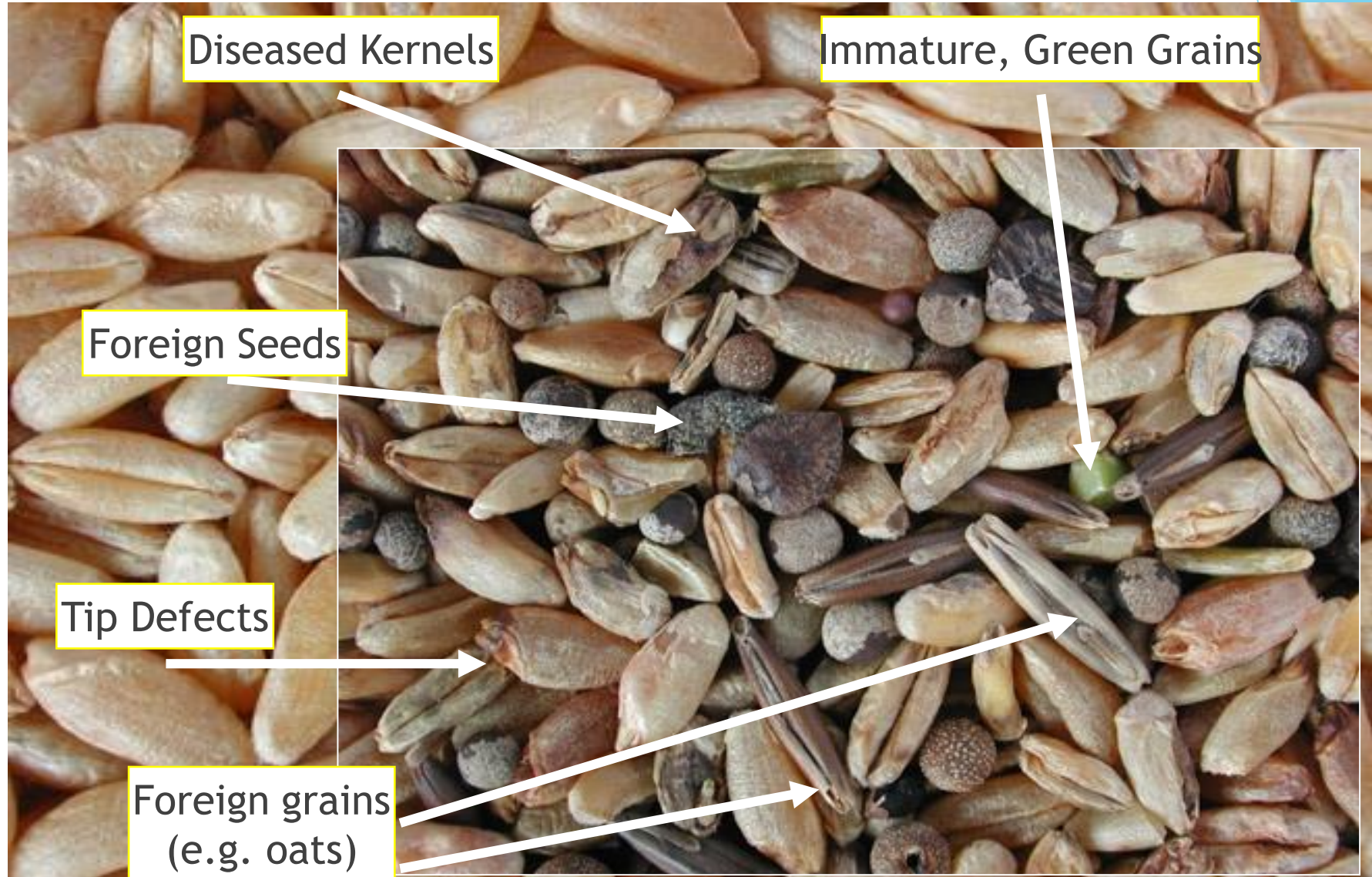



Optical Color Sorter Fractions





Optical Color Sorter Fractions



Removal of Vomitoxin Infected Wheat Fraction

Color Sorter Used to Remove Vomitoxin Infected

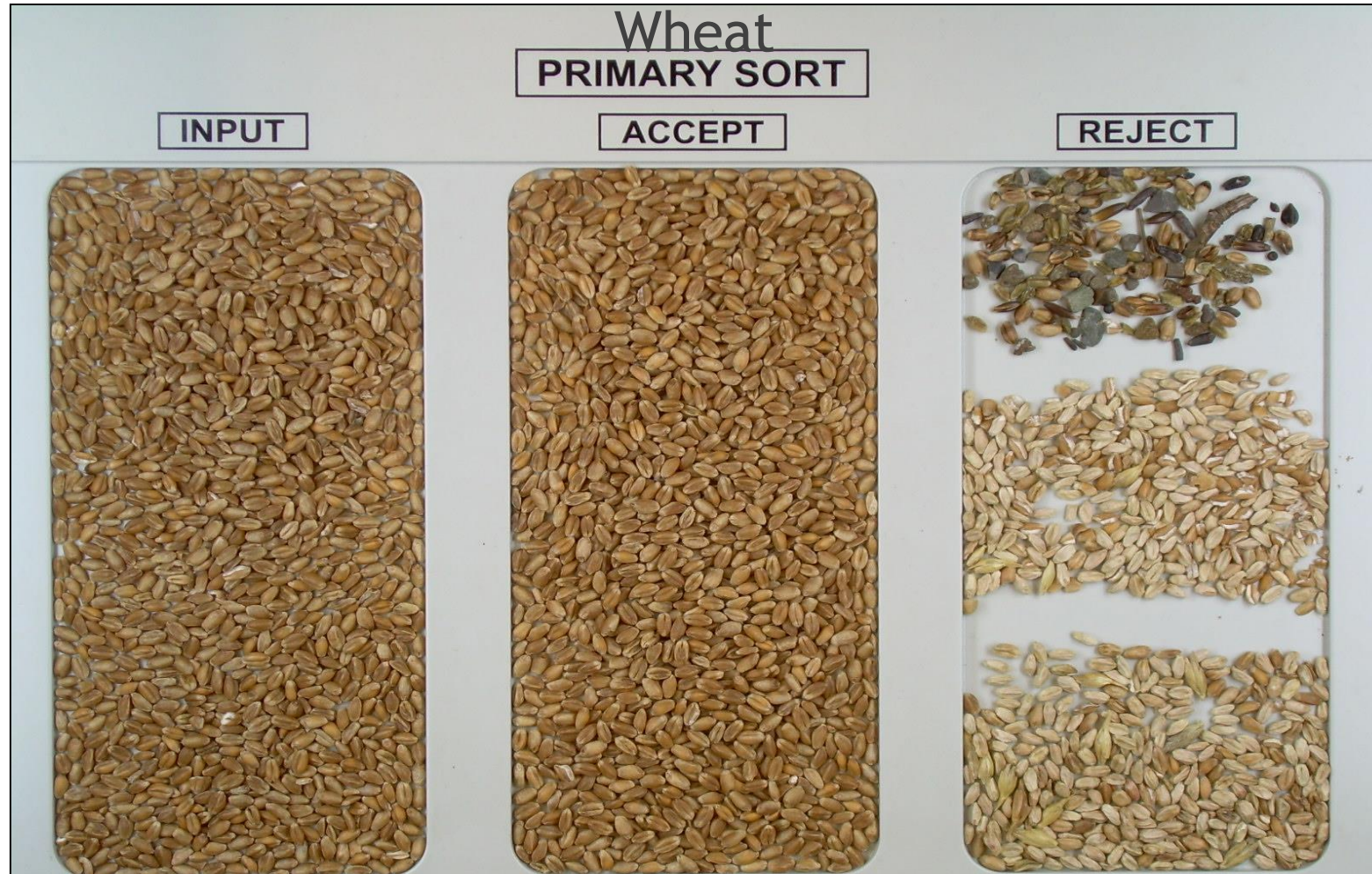

Cleaning System By-products (Screenings) Grinding

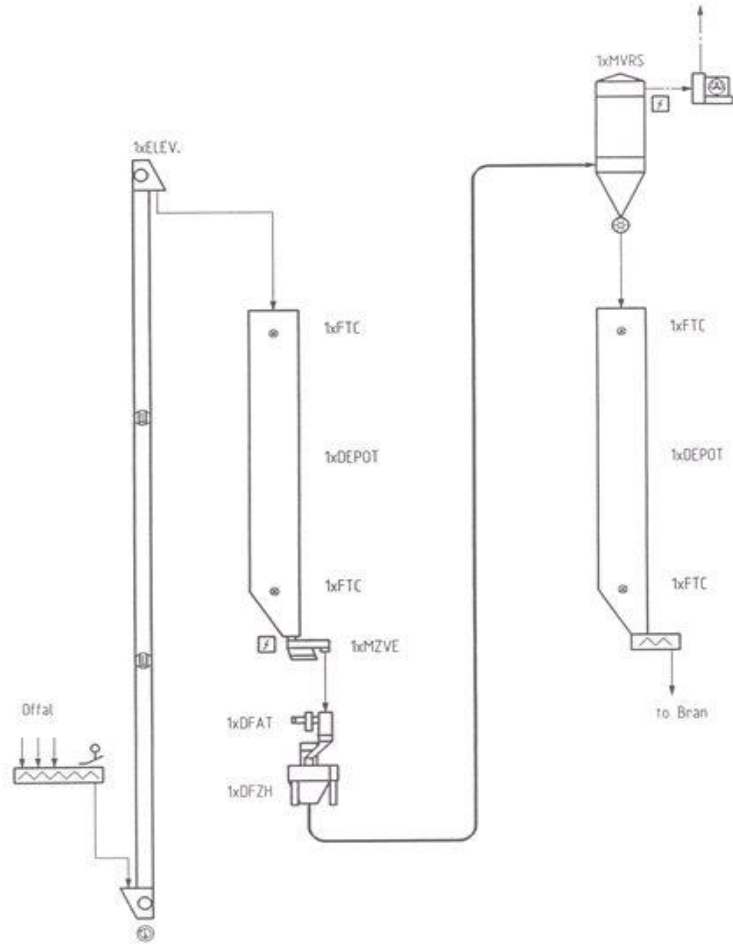

Grinding of all By-products
for Small Capacities

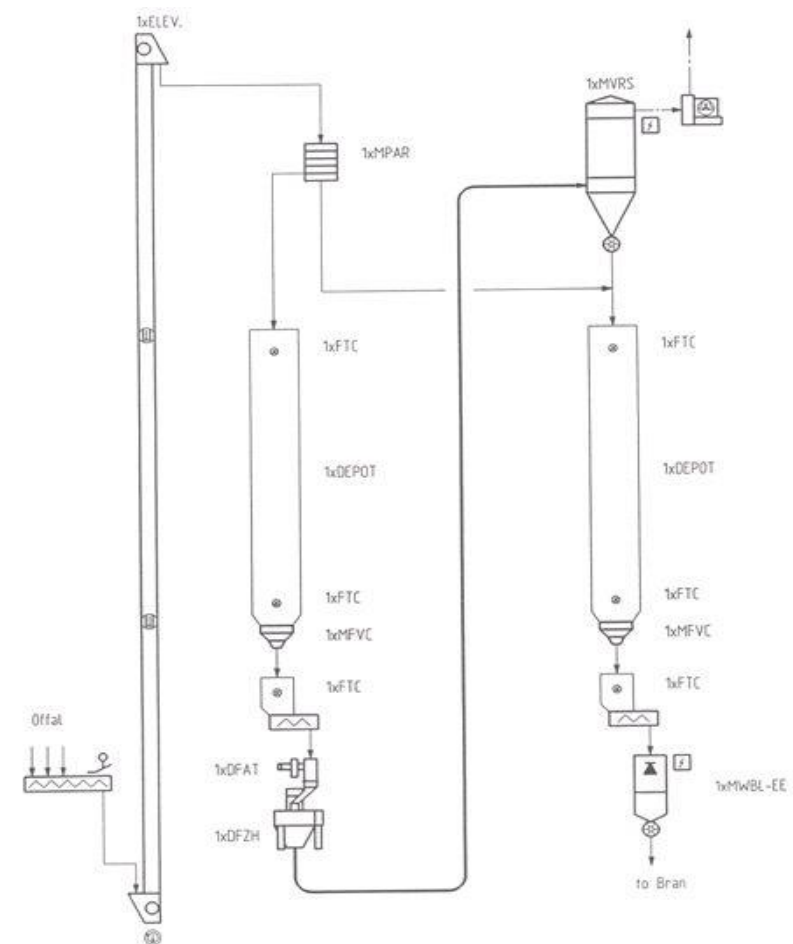

Grinding of the Coarse
By-products for High Capacities

Wheat Kernel Crease

Healthy Kernel (Crease)

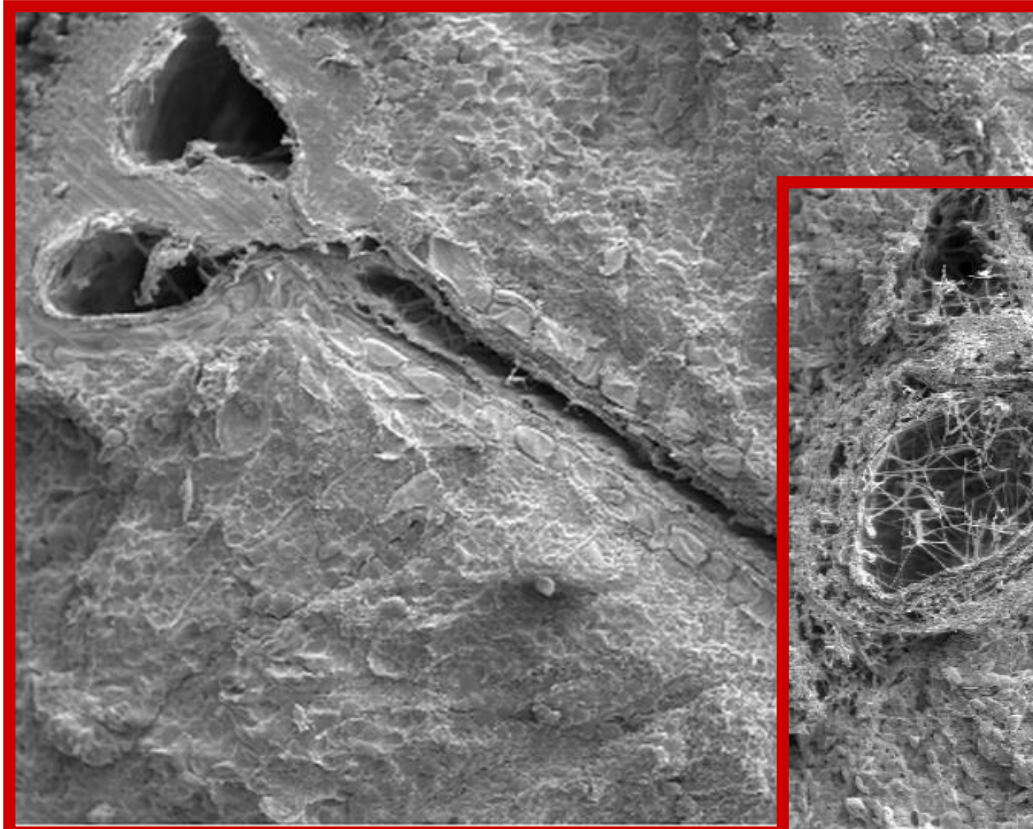

Affected Crease

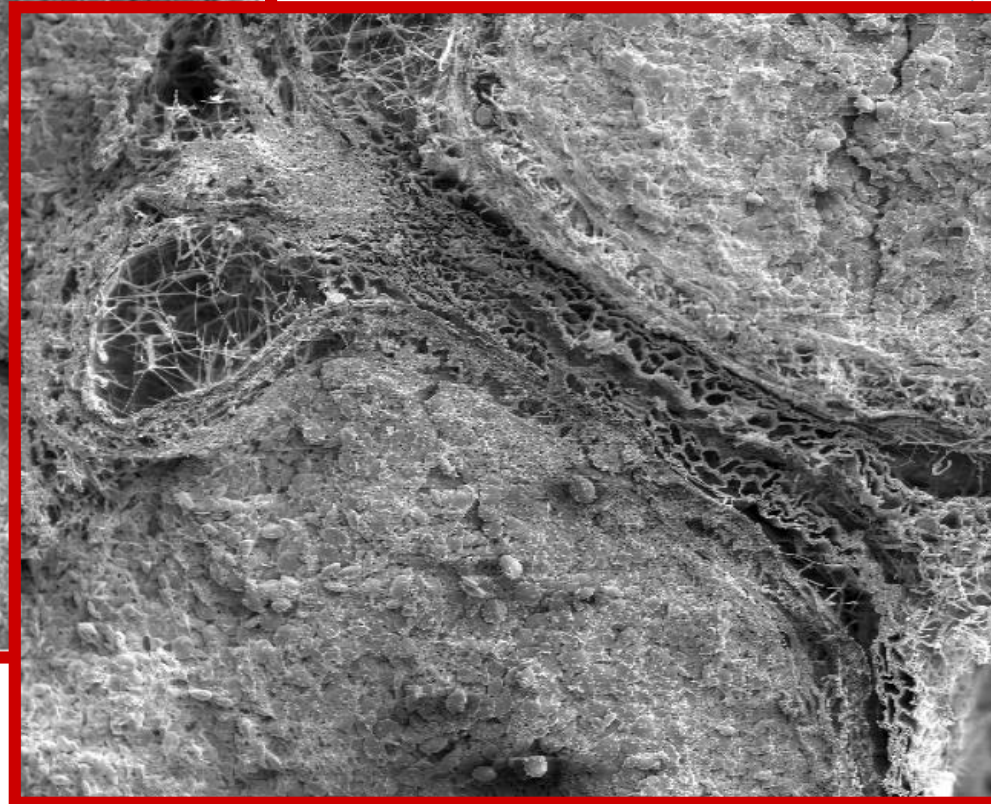



Reduction in Vomitoxin (DON) Raw wheat < 4ppm (DON)

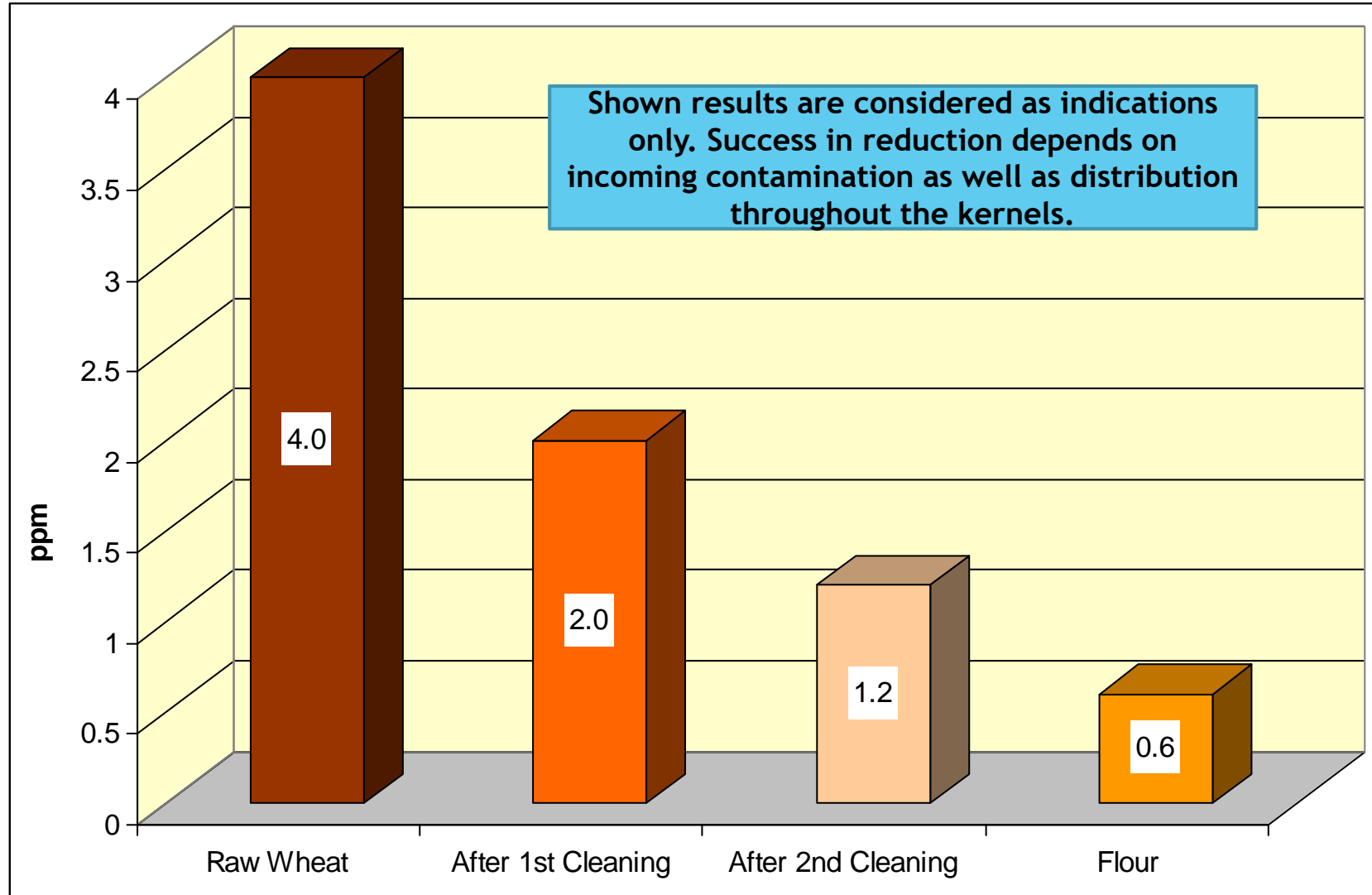

Peeling Process Uses “Friction”

Before Peeling

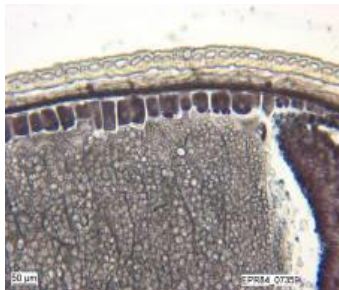

After Peeling

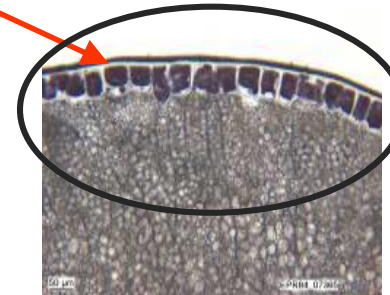
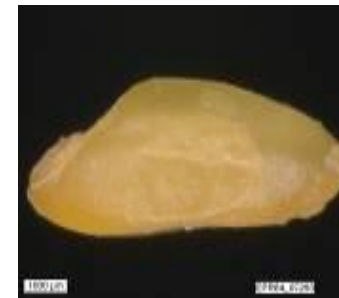

Debranner

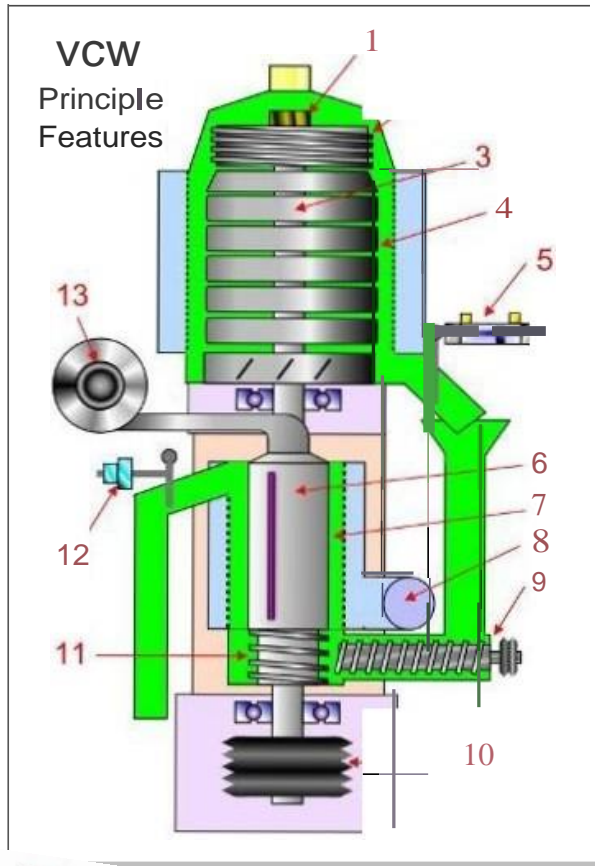

1. Clamping Nut
2. Abrasion Distribution Scroll
3. Abrasive Wheels
4. Abrasion Chamber and Screen
5. Autoweight on Abrasion Outlet
6. Friction Rotor
7. Friction Chamber and Screen
8. Exhaust Duct
9. Friction Inlet Screw Feeder
10. Main Drive
11. Friction Distribution Scroll
12. Friction Outlet Flap Gate
13. Fan

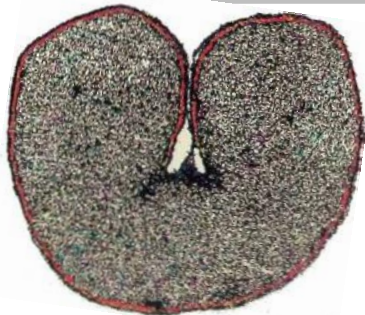

Non Debranned
Wheat



Debranned
Wheat

Comparison Peeling versus Pearling

❖ Peeling

Friction kernel against kernel. The dampened kernels are intensively rubbed against each other until the most outer layers are peeled off. The peeling process can be compared to peeling of an orange.



❖ Pearling

Friction kernel against grind stone (corundum). The friction principle could be compared to the grating of a lemon skin. It is quite difficult to ensure that the seed coat is not damaged.





Summary

- ❖ Every crop is different.
- ❖ There is no single machine or system that's 100% effective in mechanical separation.
- ❖ Dirty wheat reduces flour quality.
- ❖ Losing good wheat to screening is an economic loss.
- ❖ Losing good wheat suggests worn or improper machine setting.
- ❖ Understanding principles of cleaning flow and principles of separation will allow optimized performance.





Summary

- ❖ It is important for the Miller to know what the end result should look like when a product exits each cleaning machine.
- ❖ Major variations in the finished product can be a clue that machine adjustments or maintenance may be needed.





Summary

Cleaning and tempering is an essential part of the milling process. Successful control and management of the cleaning and tempering operations can improve mill performance and avoid problems that result in an increased cost and reduced profitability. This is a very critical part of the milling operation.





Thank You!

Siemer Milling Company
Teutopolis, Illinois

